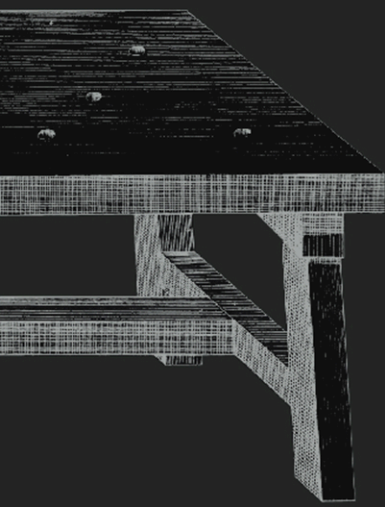


# Interior de artista

Nelson Plaza



av

Ediciones Departamento de Artes Visuales  
Facultad de Artes Universidad de Chile

COLECCIÓN RELATOS VISUALES





# Interior de artista

Nelson Plaza

COLECCIÓN RELATOS VISUALES



Universidad de Chile  
Facultad de Artes



Ediciones Departamento de Artes Visuales  
Facultad de Artes Universidad de Chile

## Colección Relatos Visuales

Departamento de Artes Visuales  
Facultad de Artes  
Universidad de Chile

Las Encinas 3370, Ñuñoa  
Página Web: [www.dav.uchile.cl](http://www.dav.uchile.cl)  
e-mail: [artevis@uchile.cl](mailto:artevis@uchile.cl)

Director:  
Enrique Matthey

Subdirector:  
Luis Montes

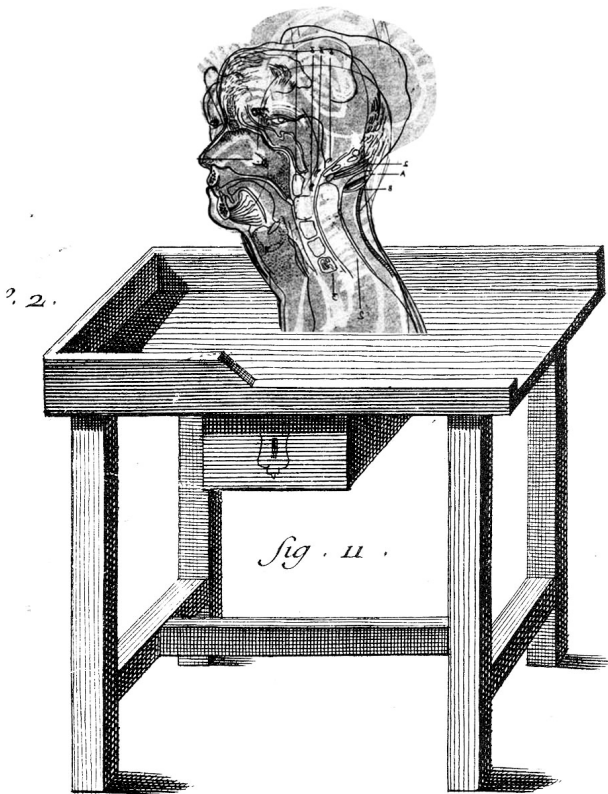
Director Extensión y Publicaciones:  
Francisco Sanfuentes

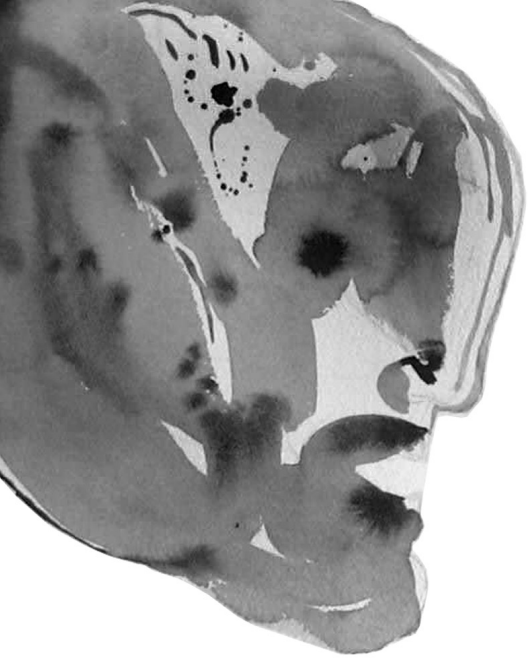
Diseño y Diagramación:  
Rodrigo Wielandt

Inscripción N°: 000000  
Registro ISBN: 000-000-00-0000-0

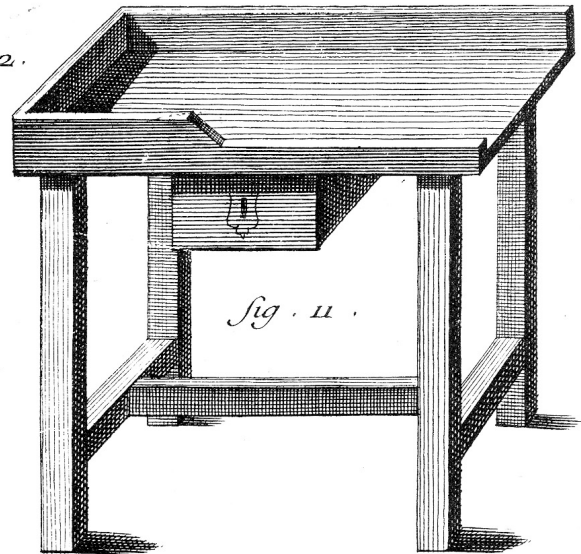
Impreso en Chile / Printed in Chile







2. 2.



*fig. 11.*



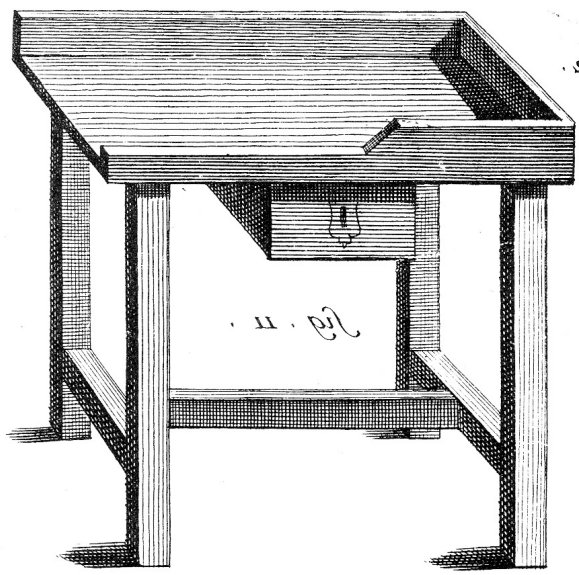
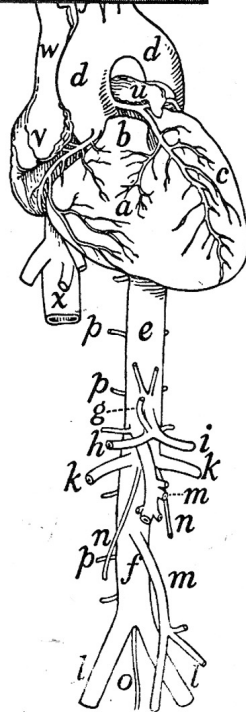
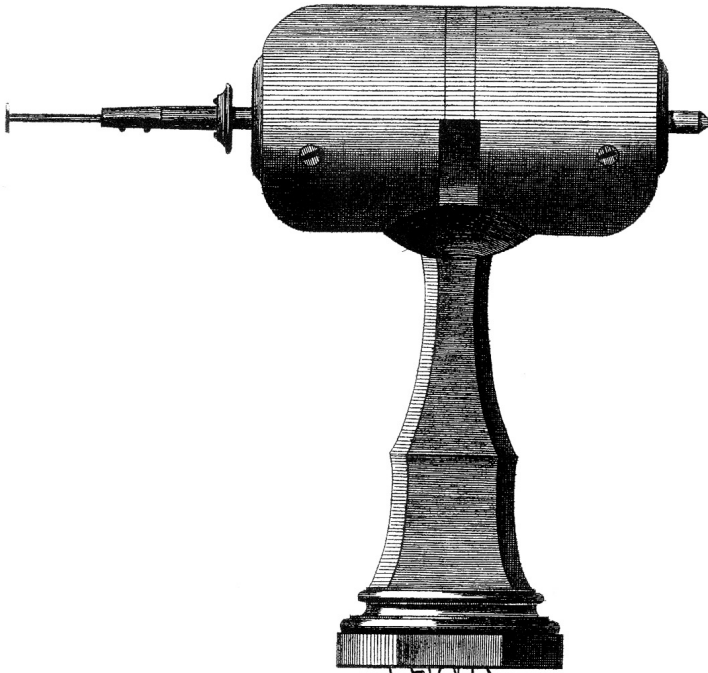


Fig. 10

Fig. 11

Fig. 1.



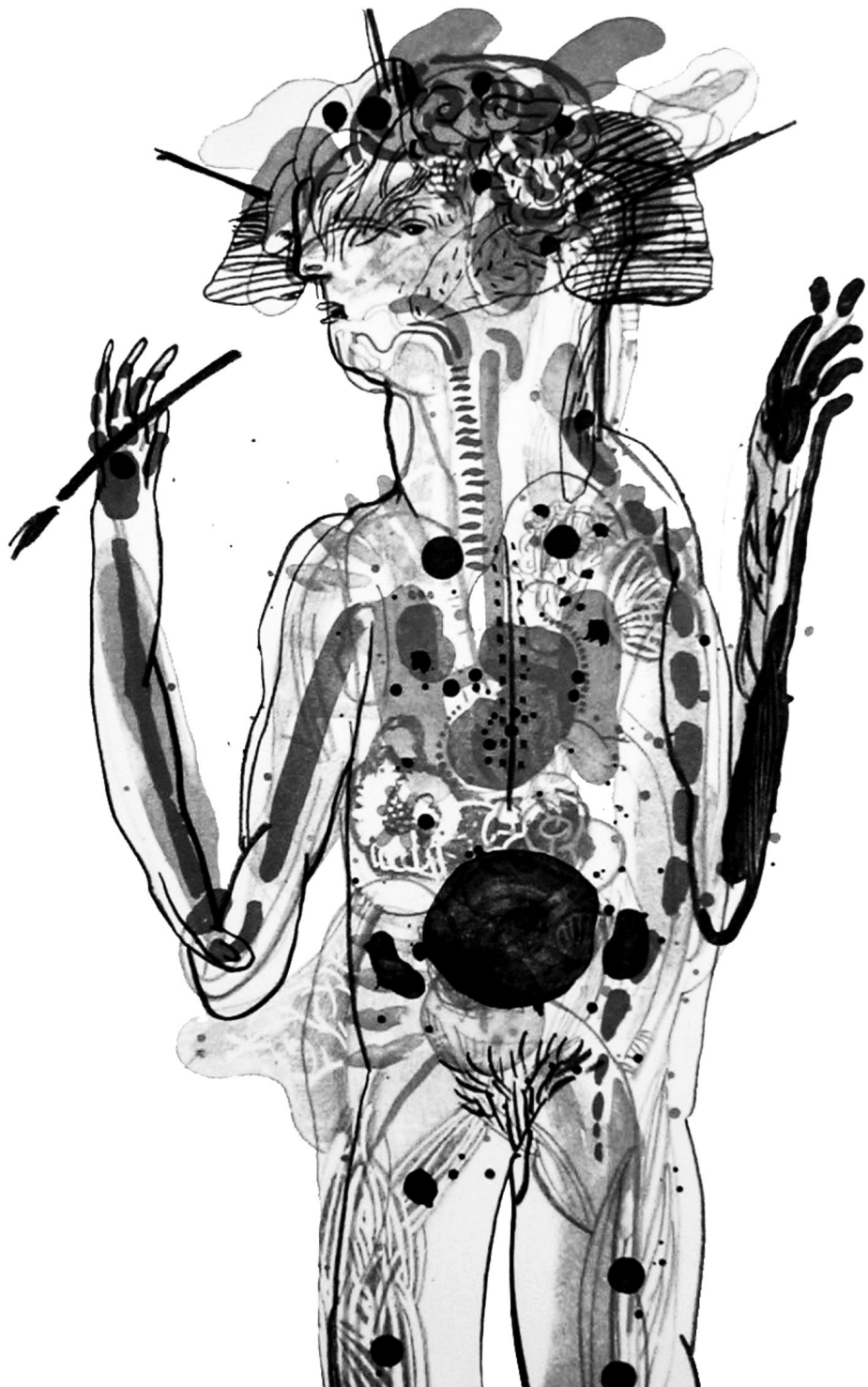
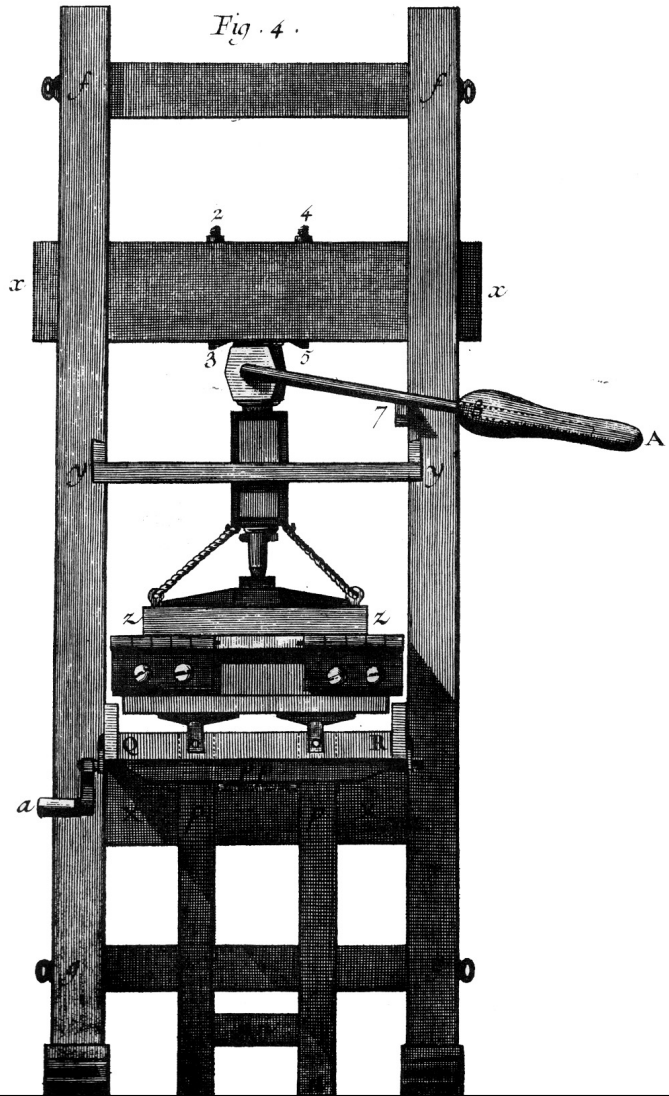
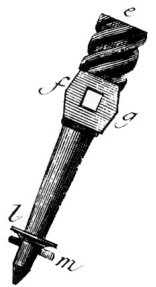
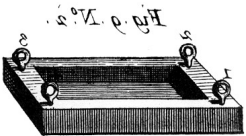




Fig. 4.







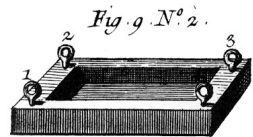
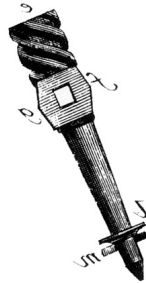
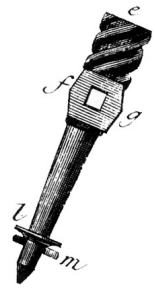
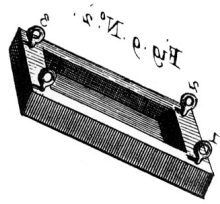
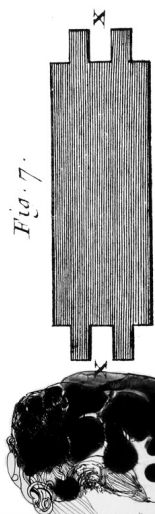




Fig. 7.



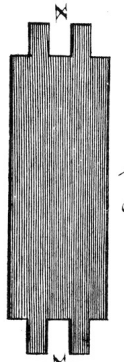
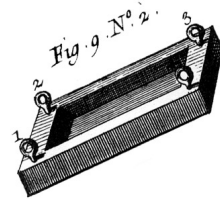
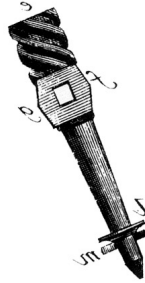
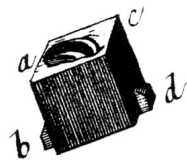
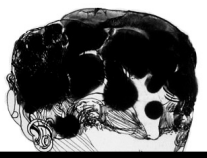
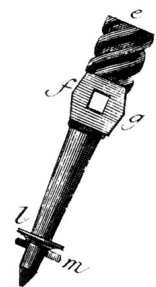
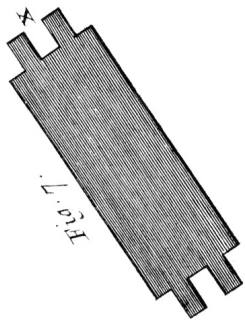
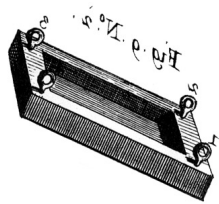
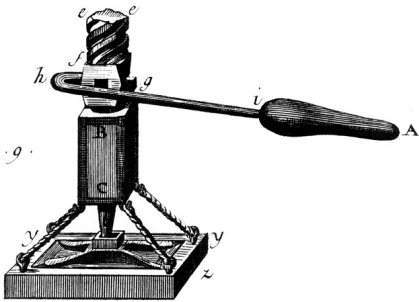
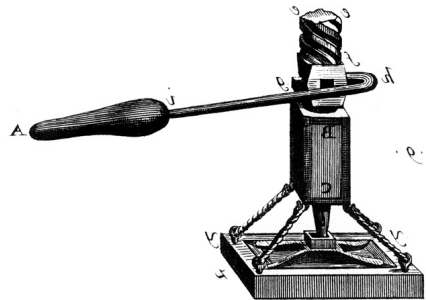
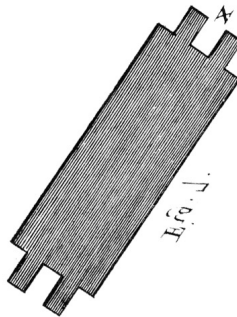
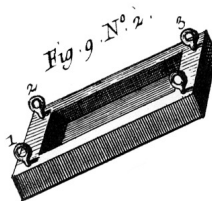
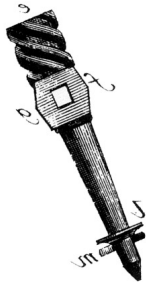


Fig. 10.

Fig. 9.





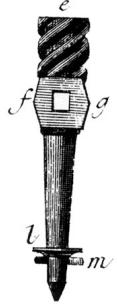
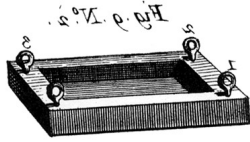
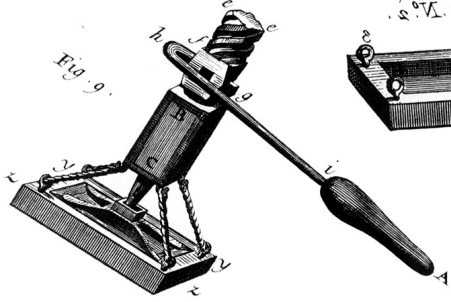
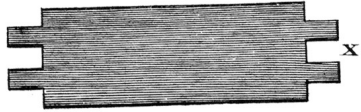
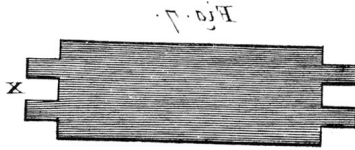
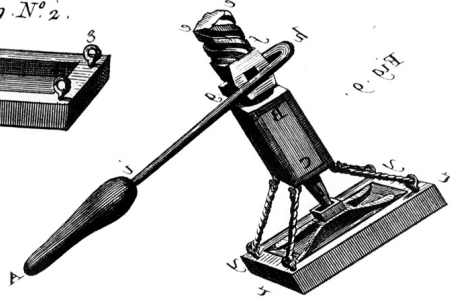
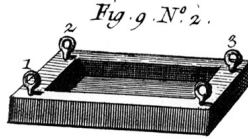


Fig. 7.





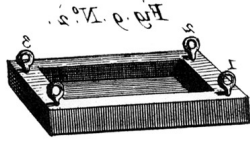
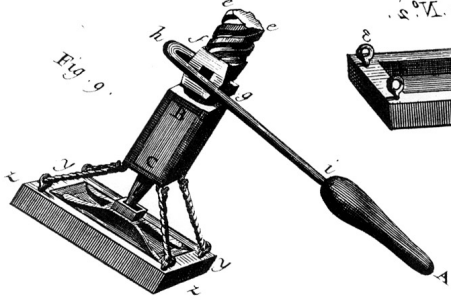
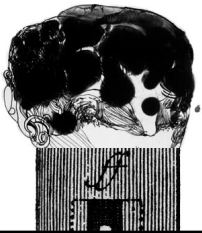
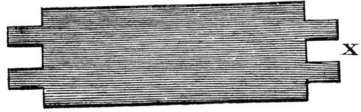
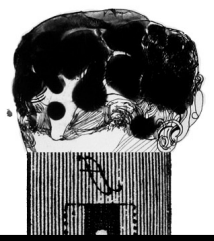
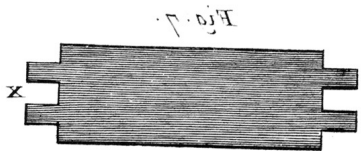
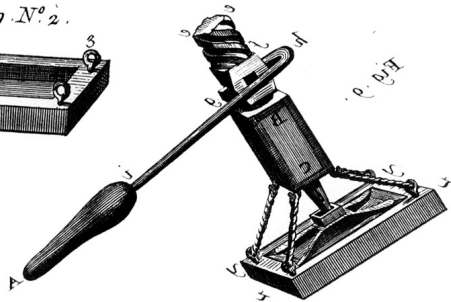
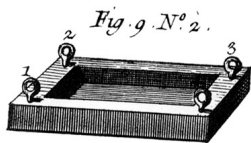
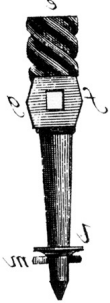


Fig. 7.







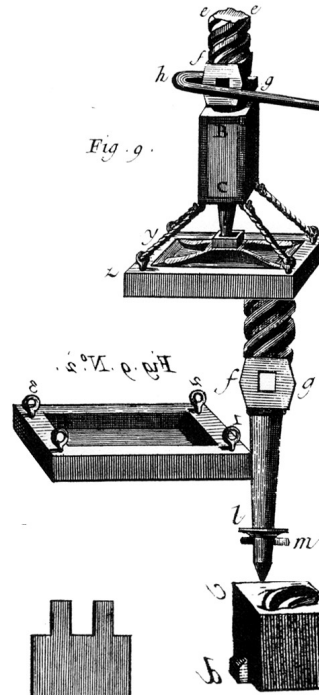


Fig. 9.

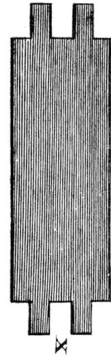


Fig. 7.

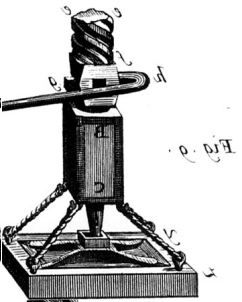


Fig. 8.

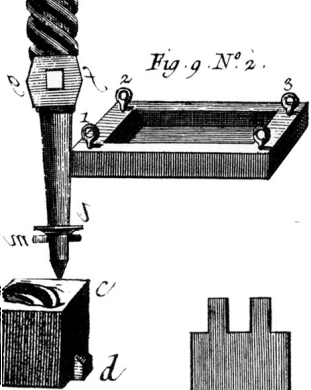
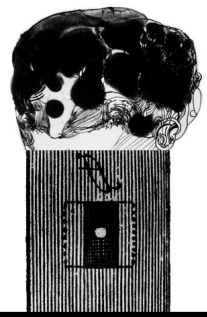
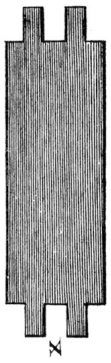


Fig. 9. N° 2.

Fig. 7.



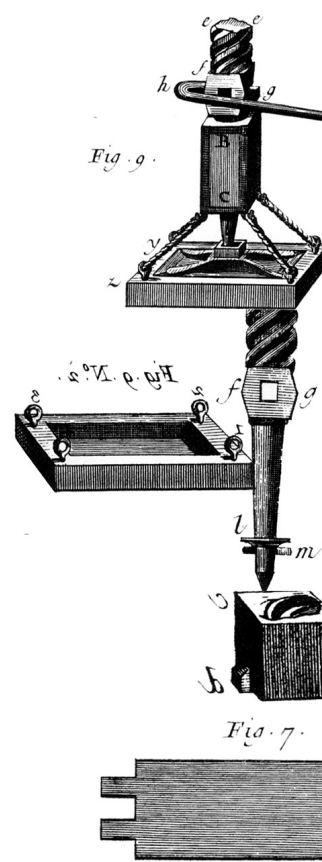
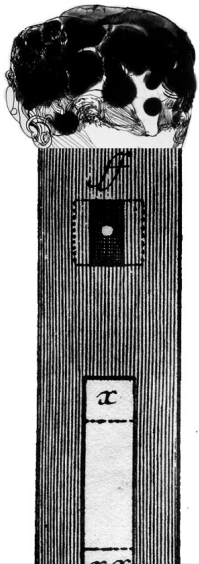
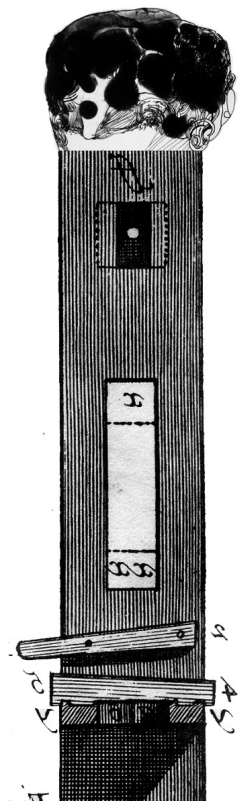
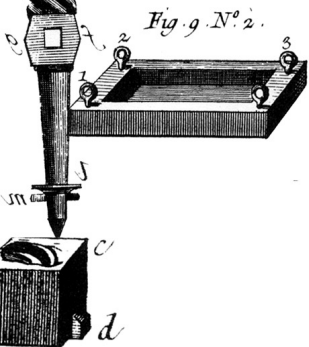
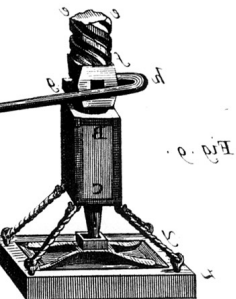
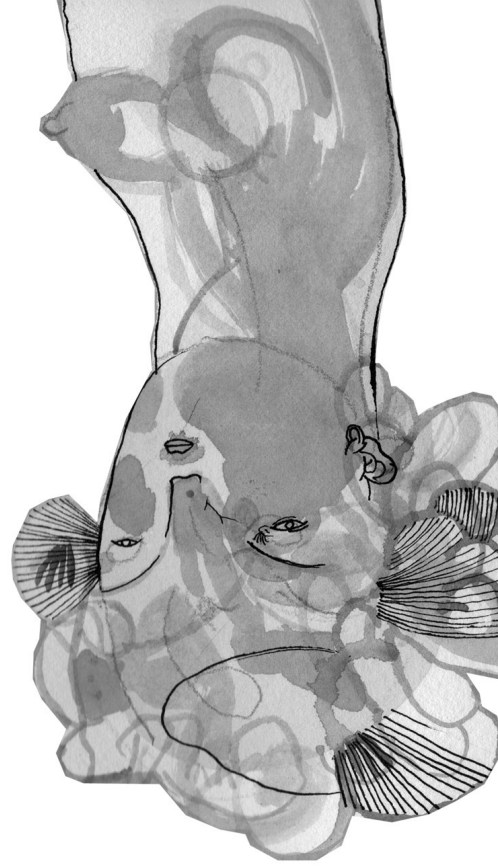
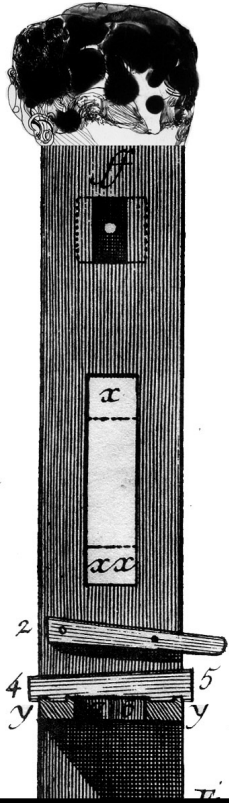
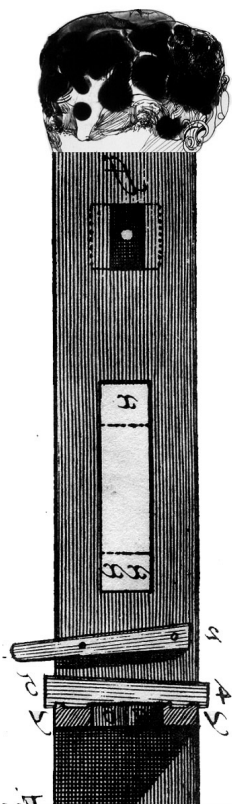


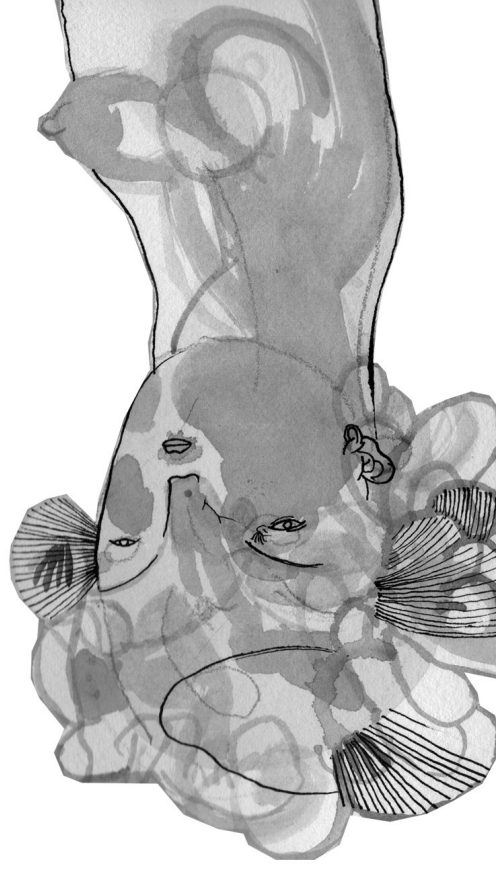
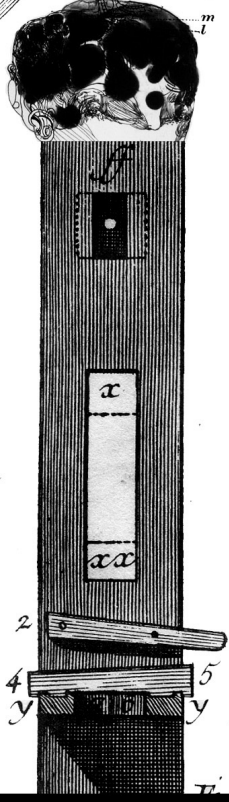
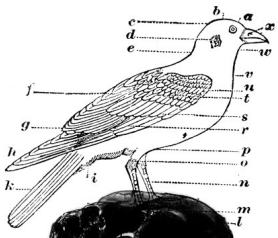
Fig. 9.

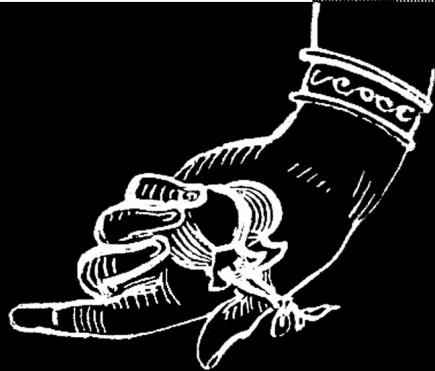
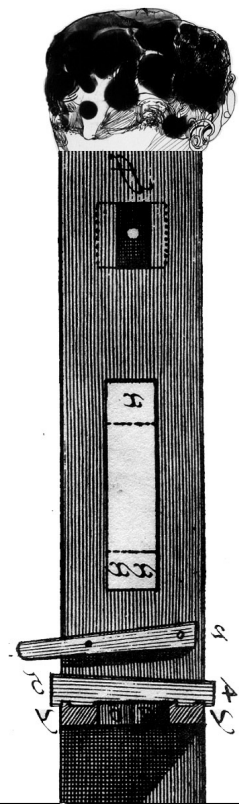
Fig. 7.



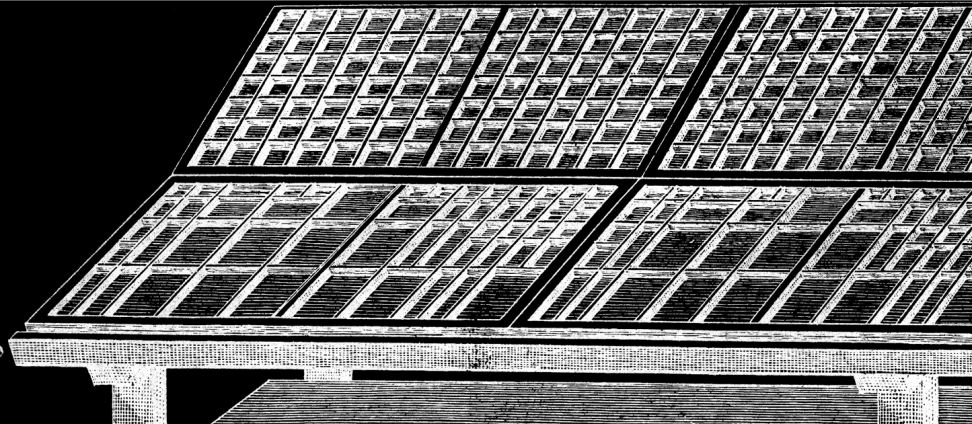
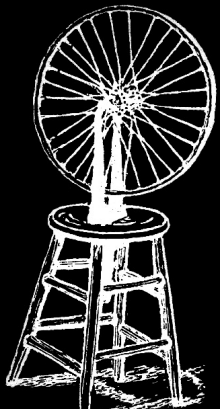
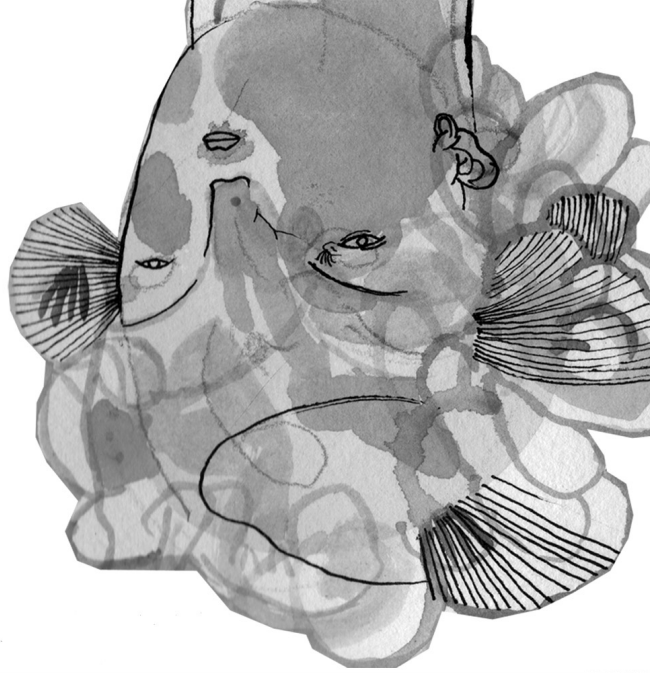
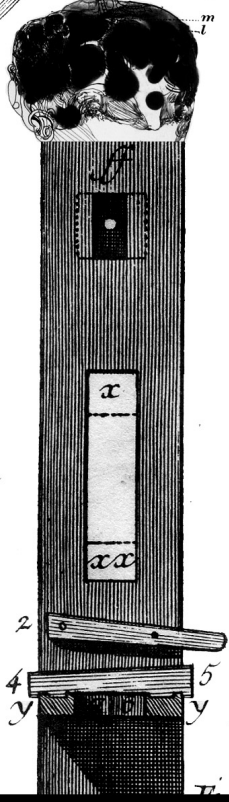
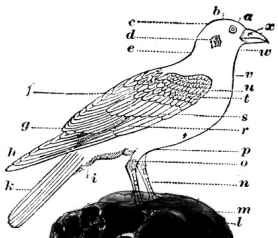


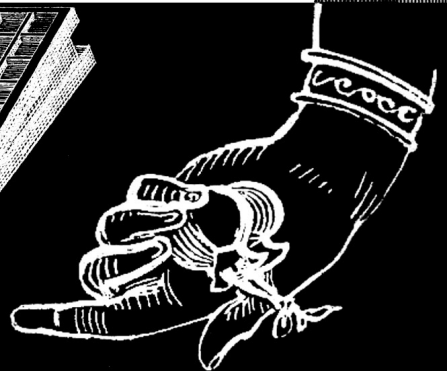
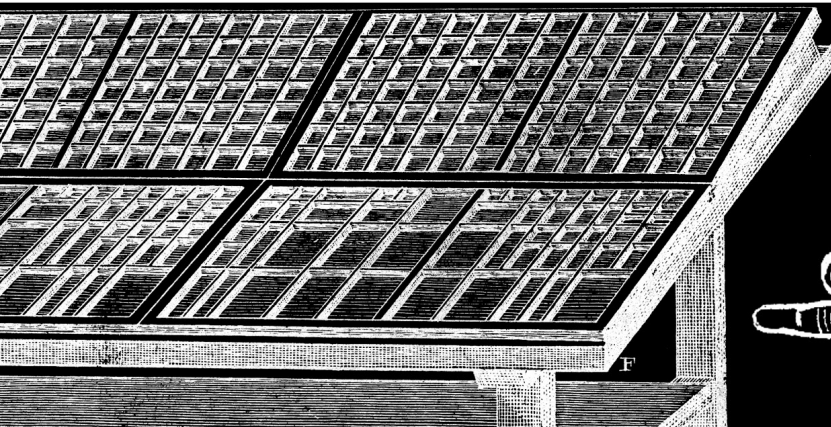
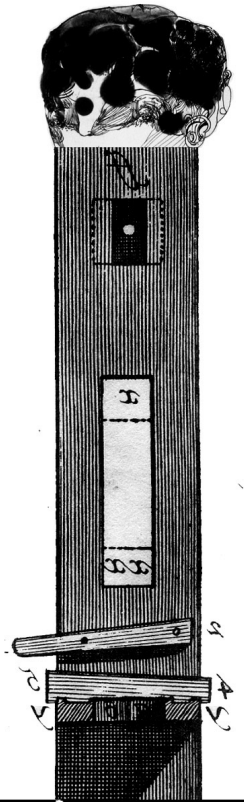












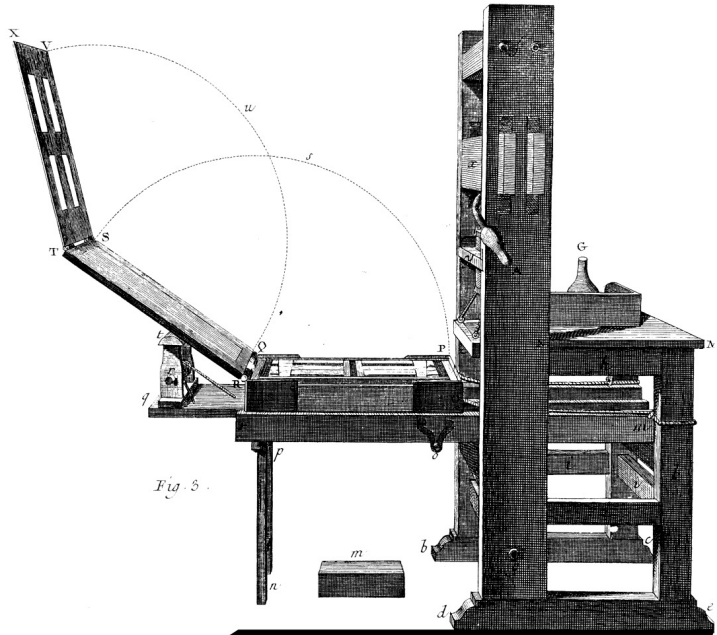
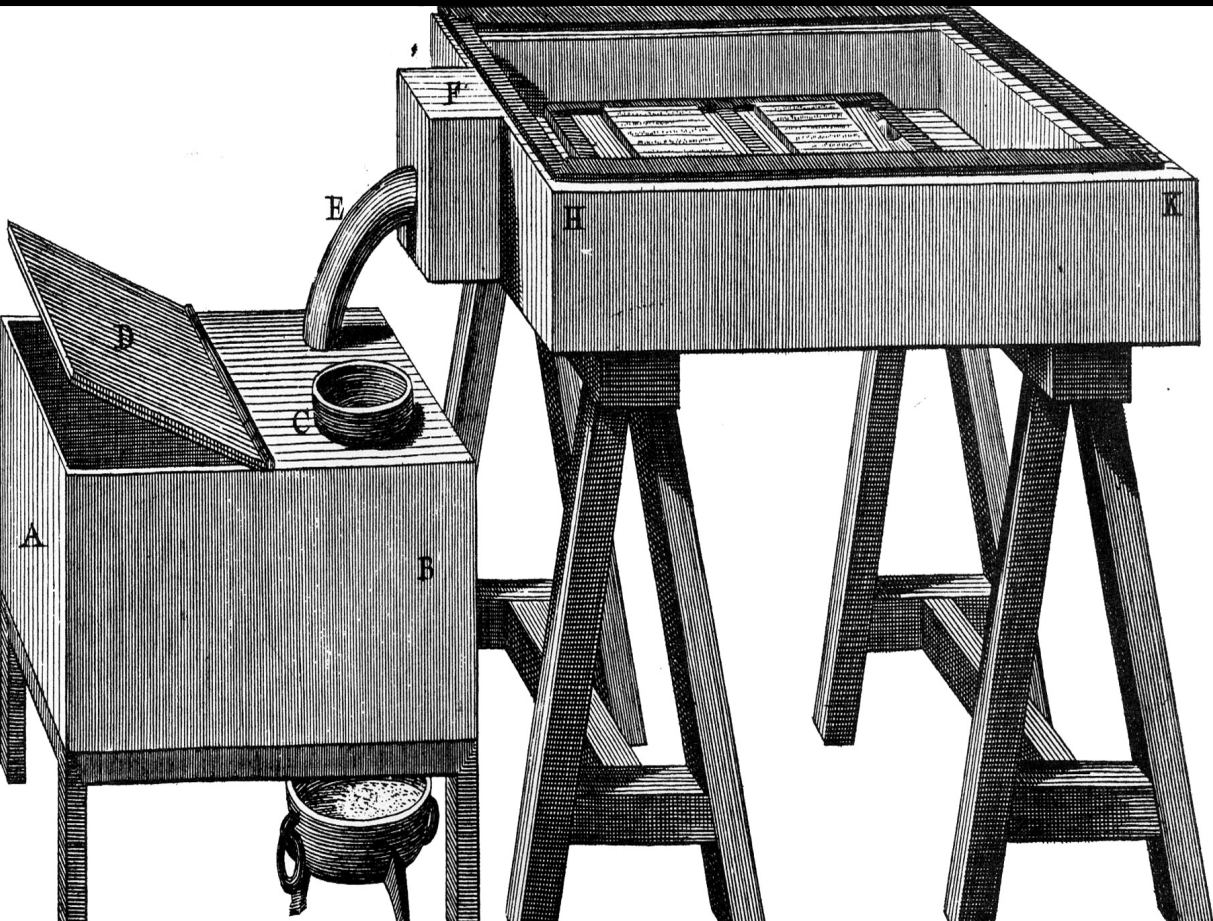


Fig. 5.



Fig. 2.



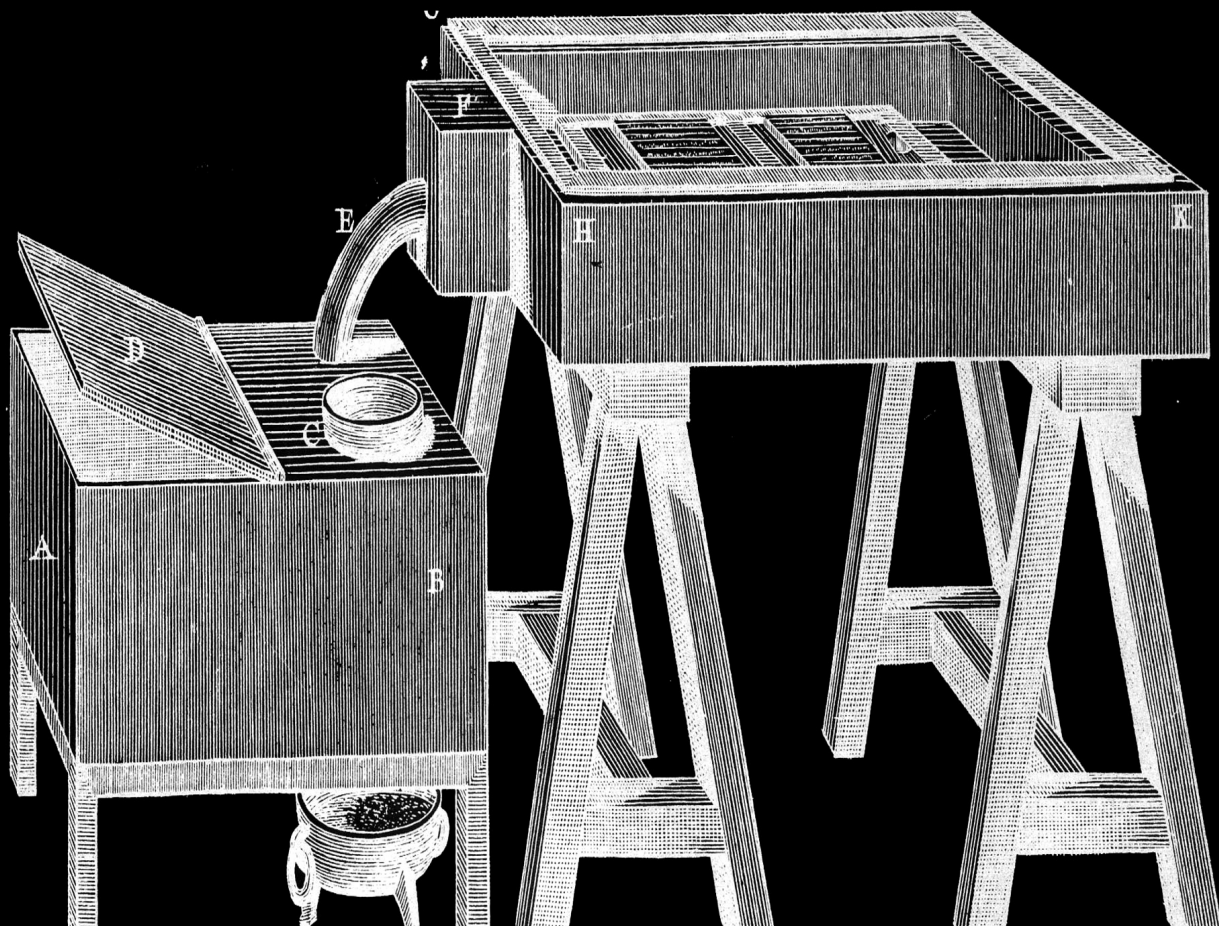
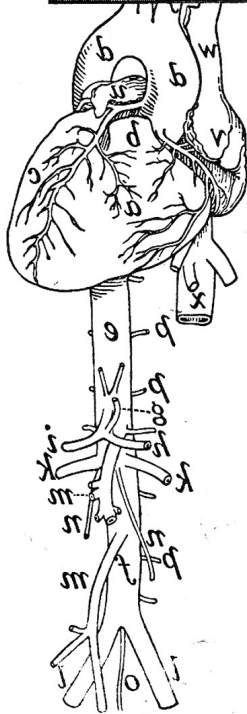
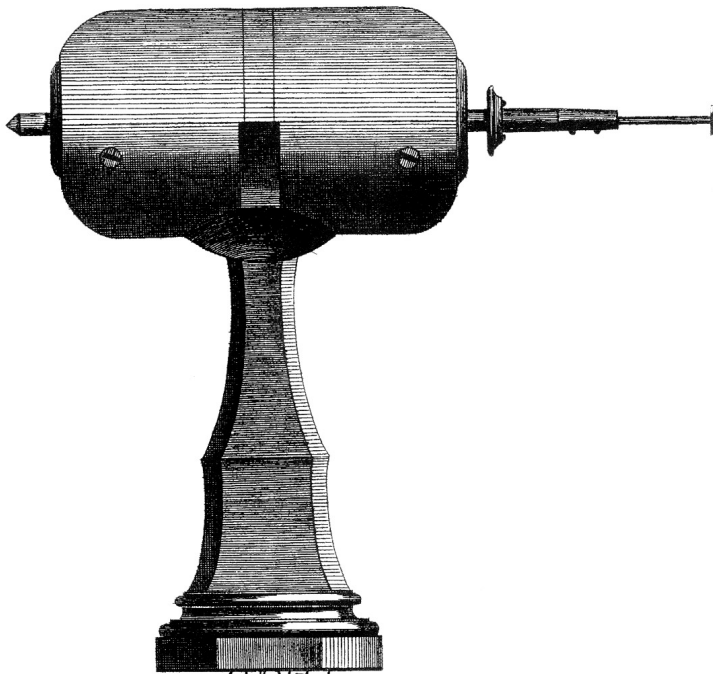
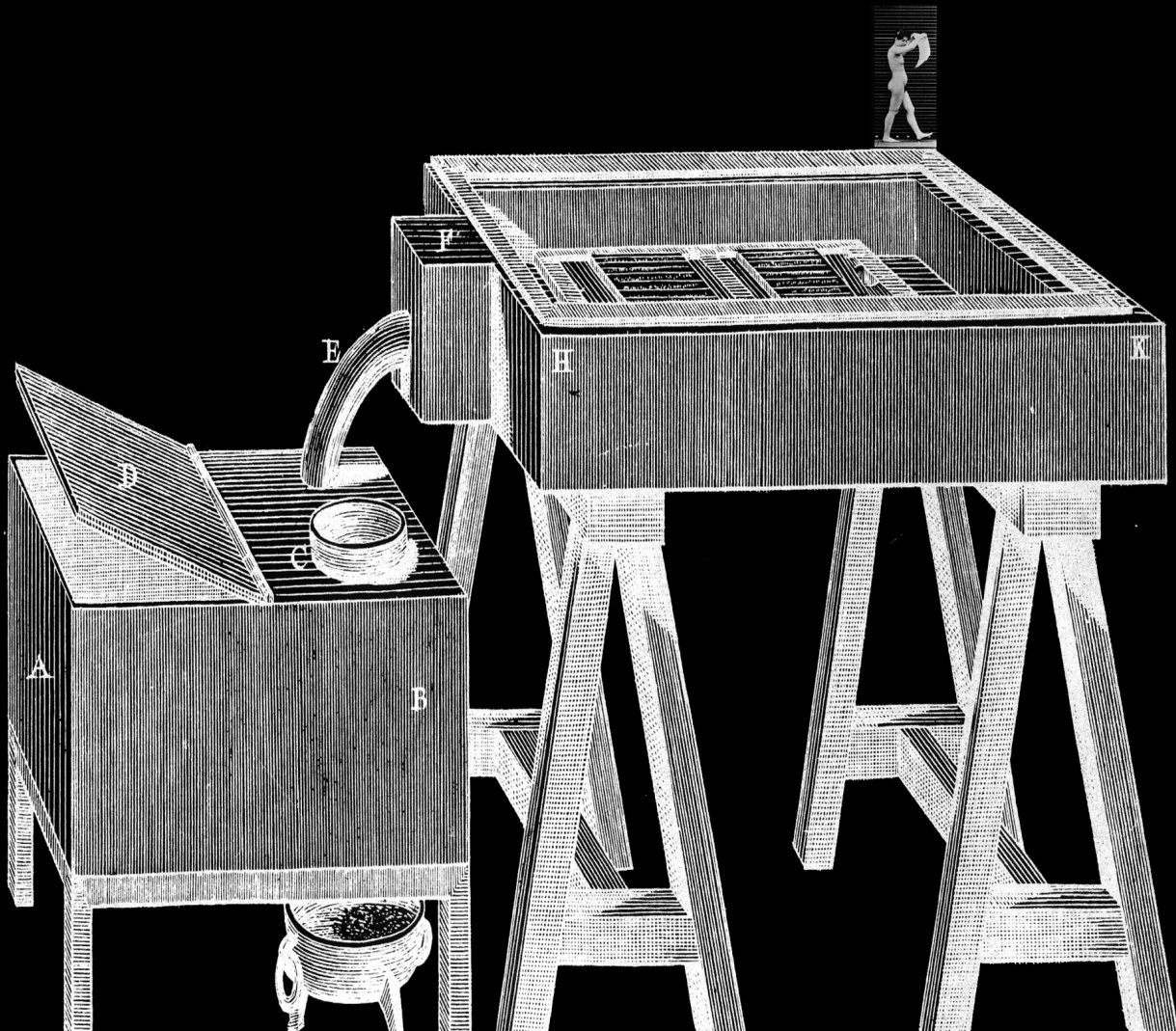
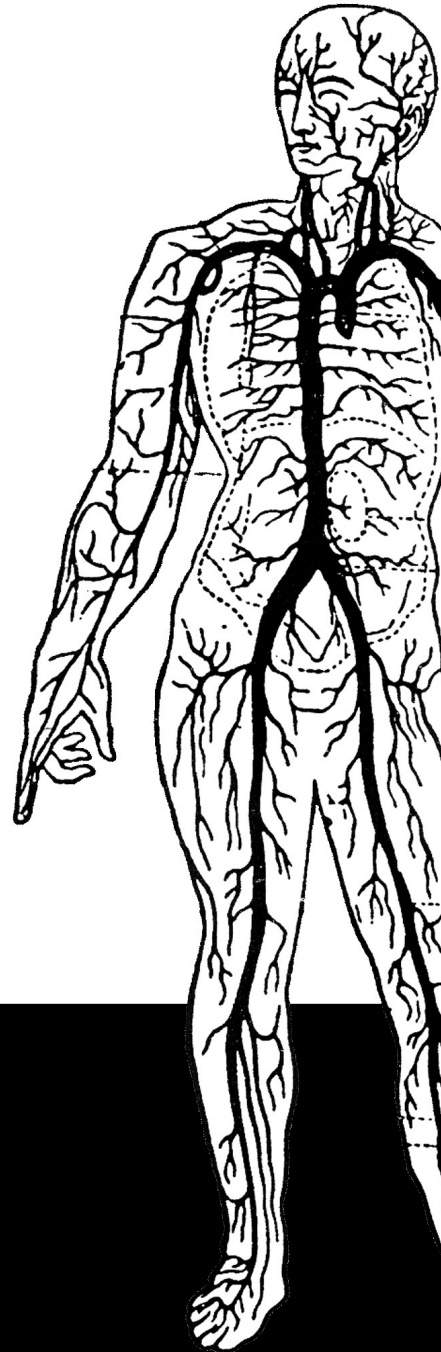


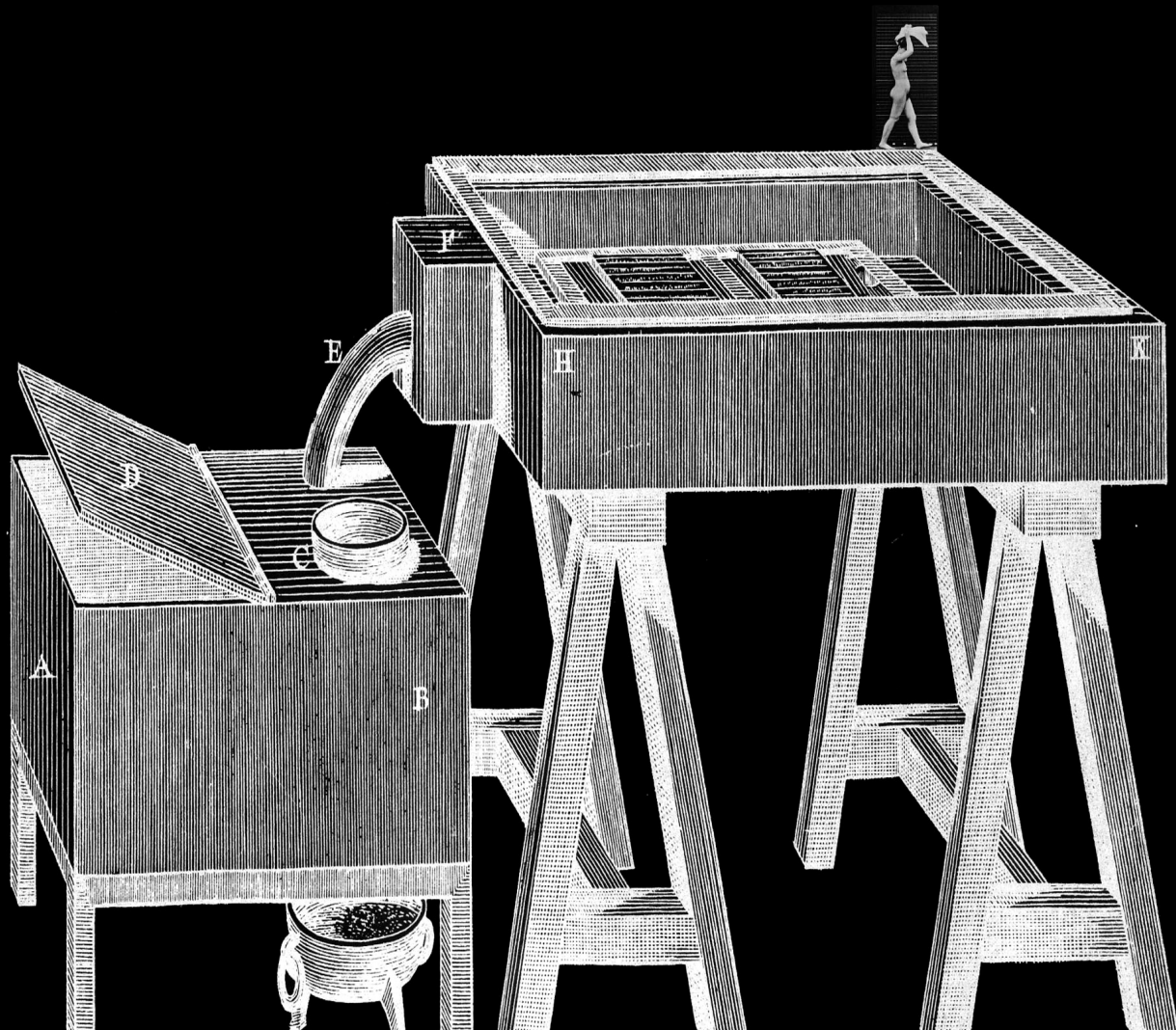
Fig. 1.

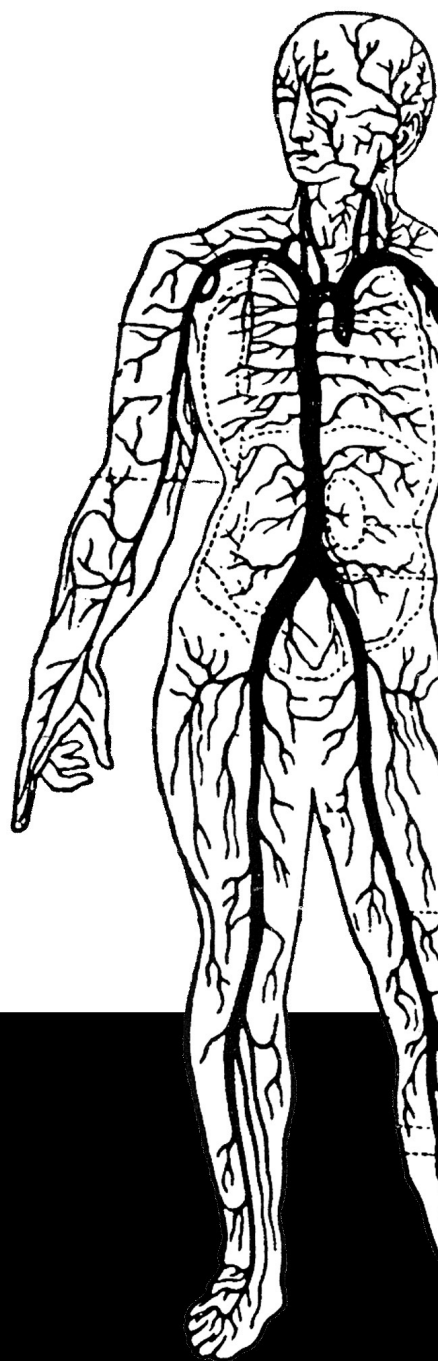
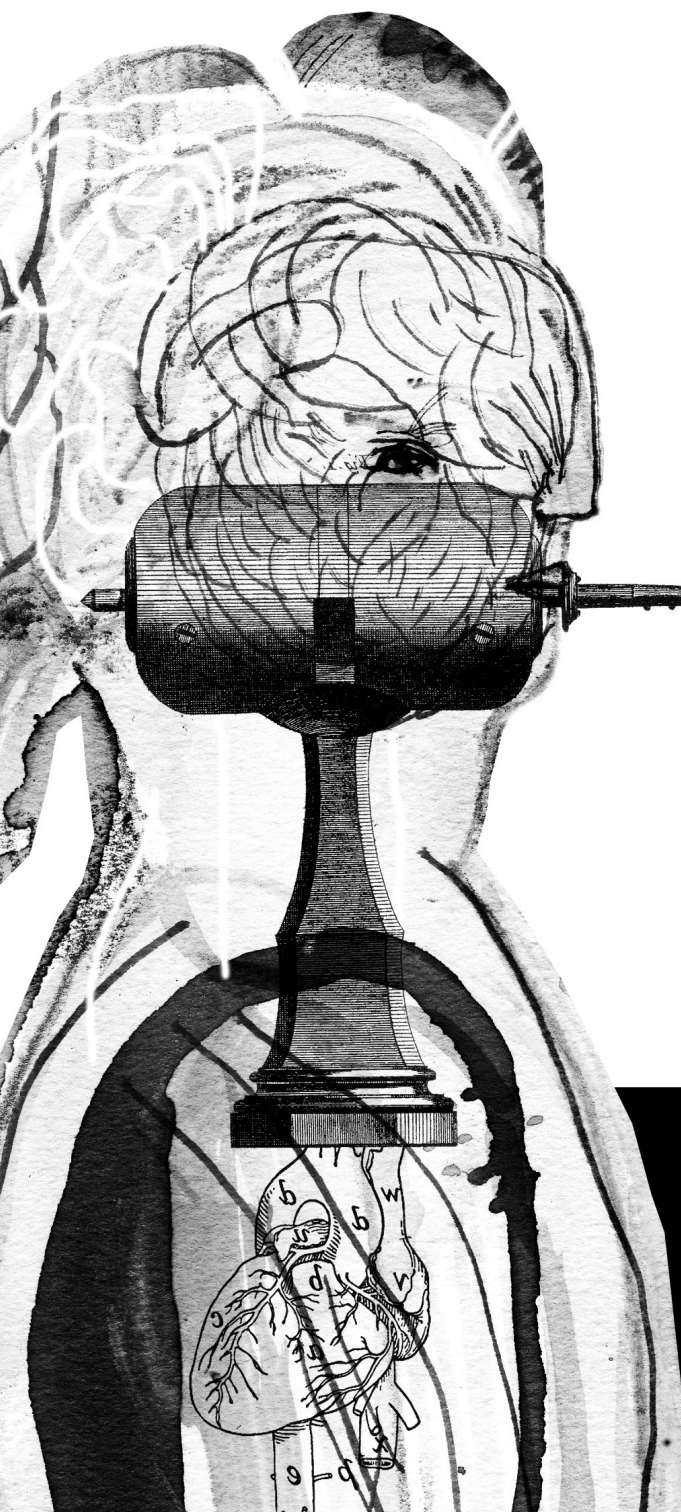


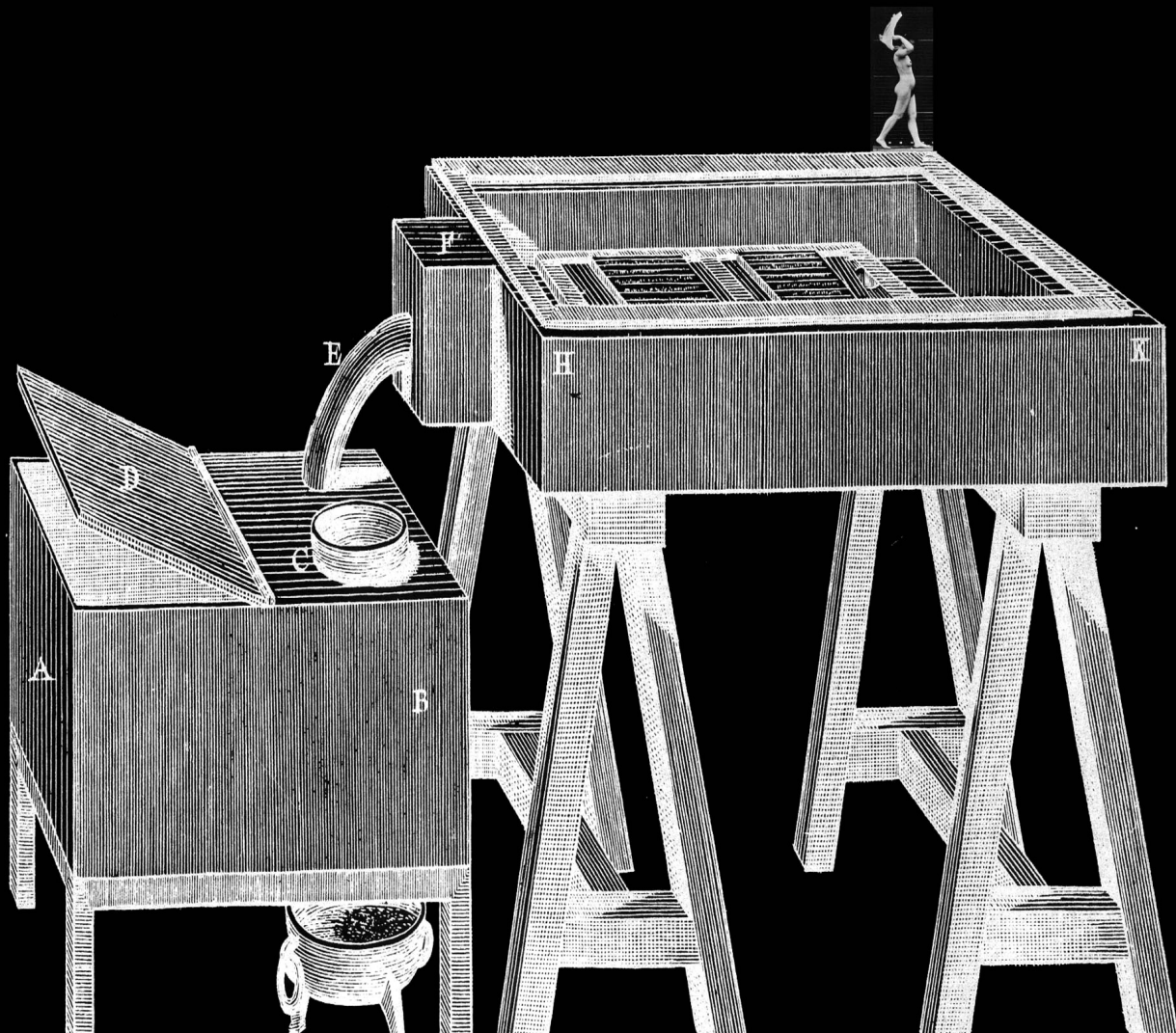


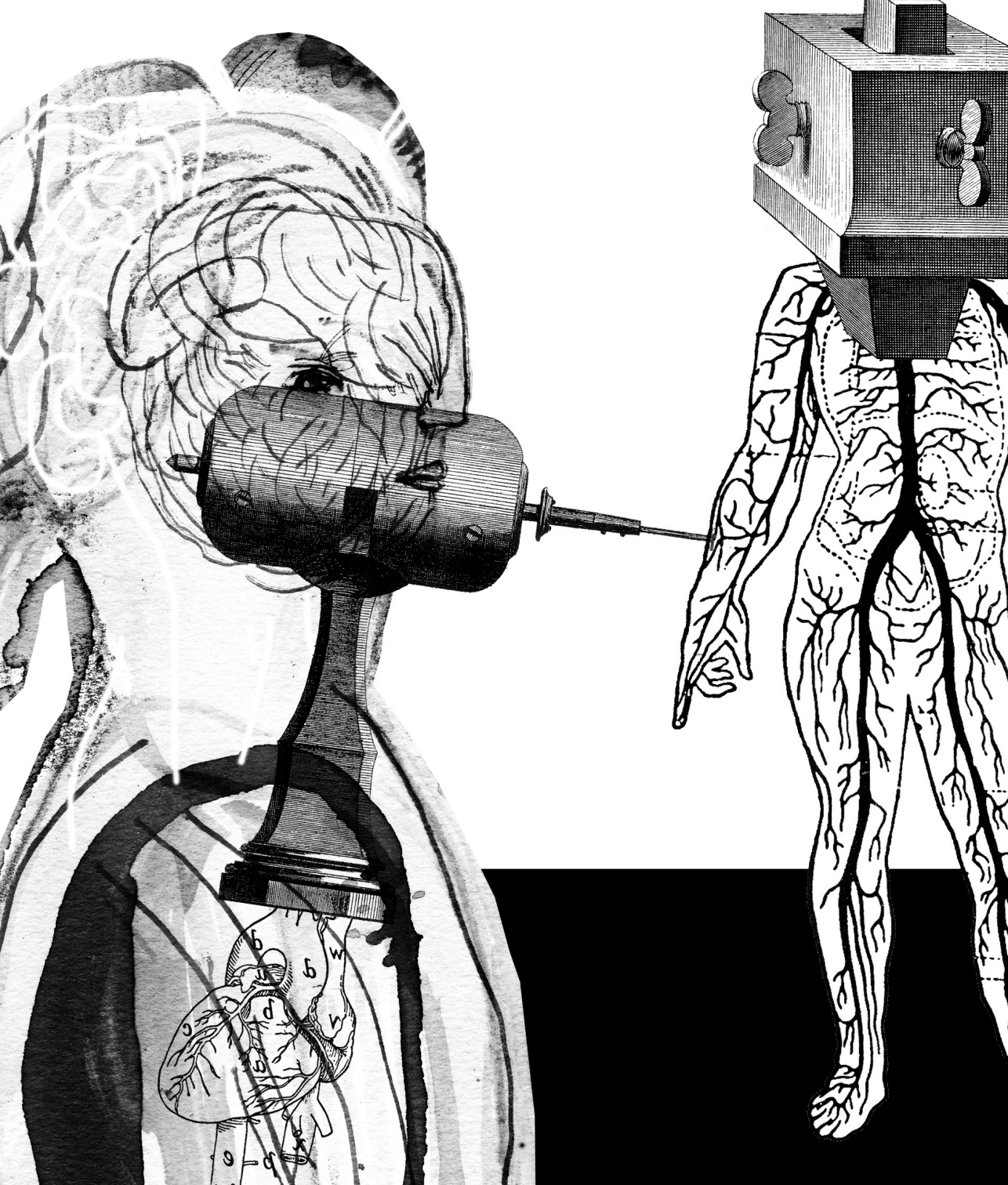


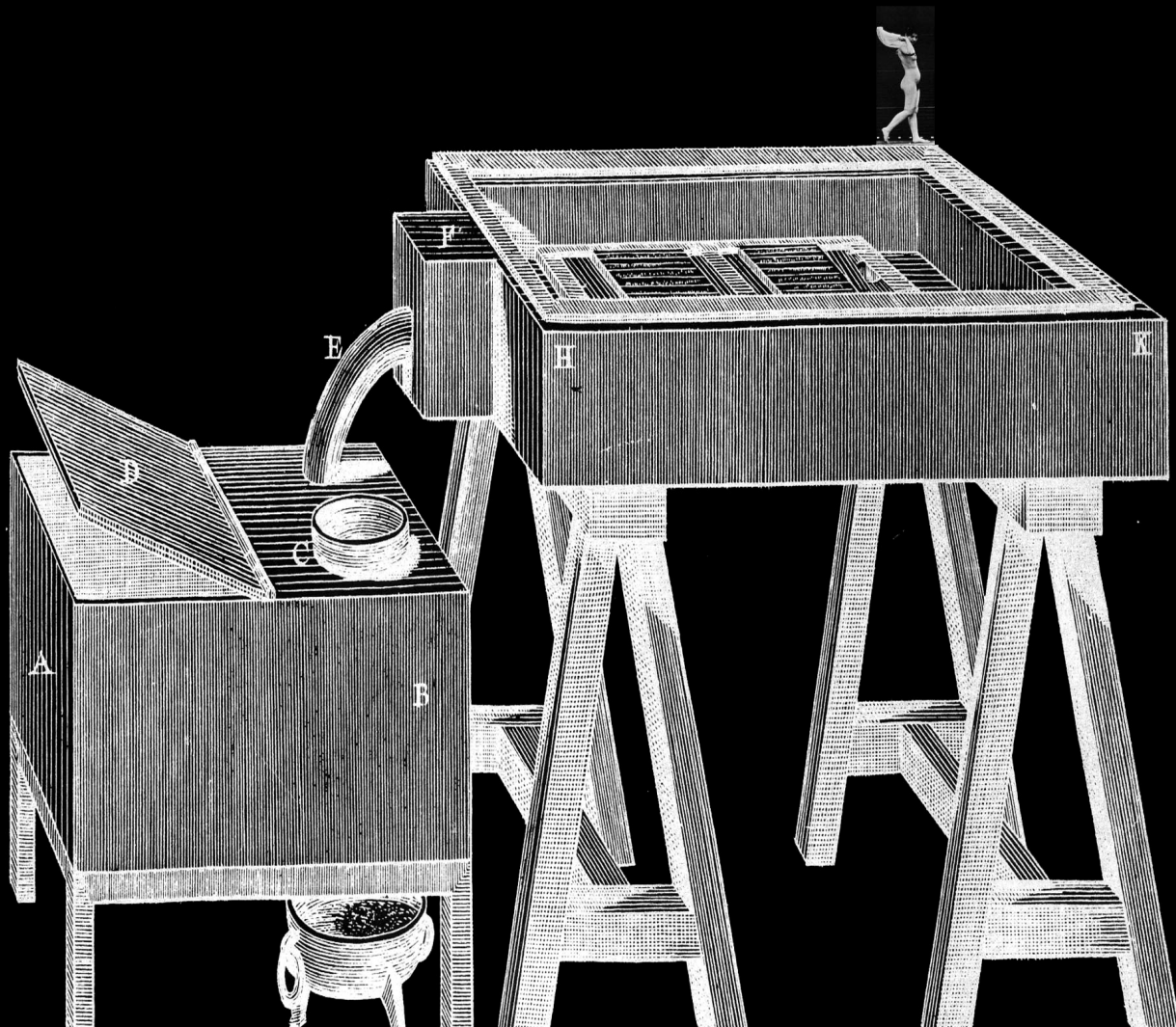


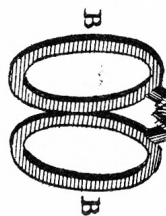


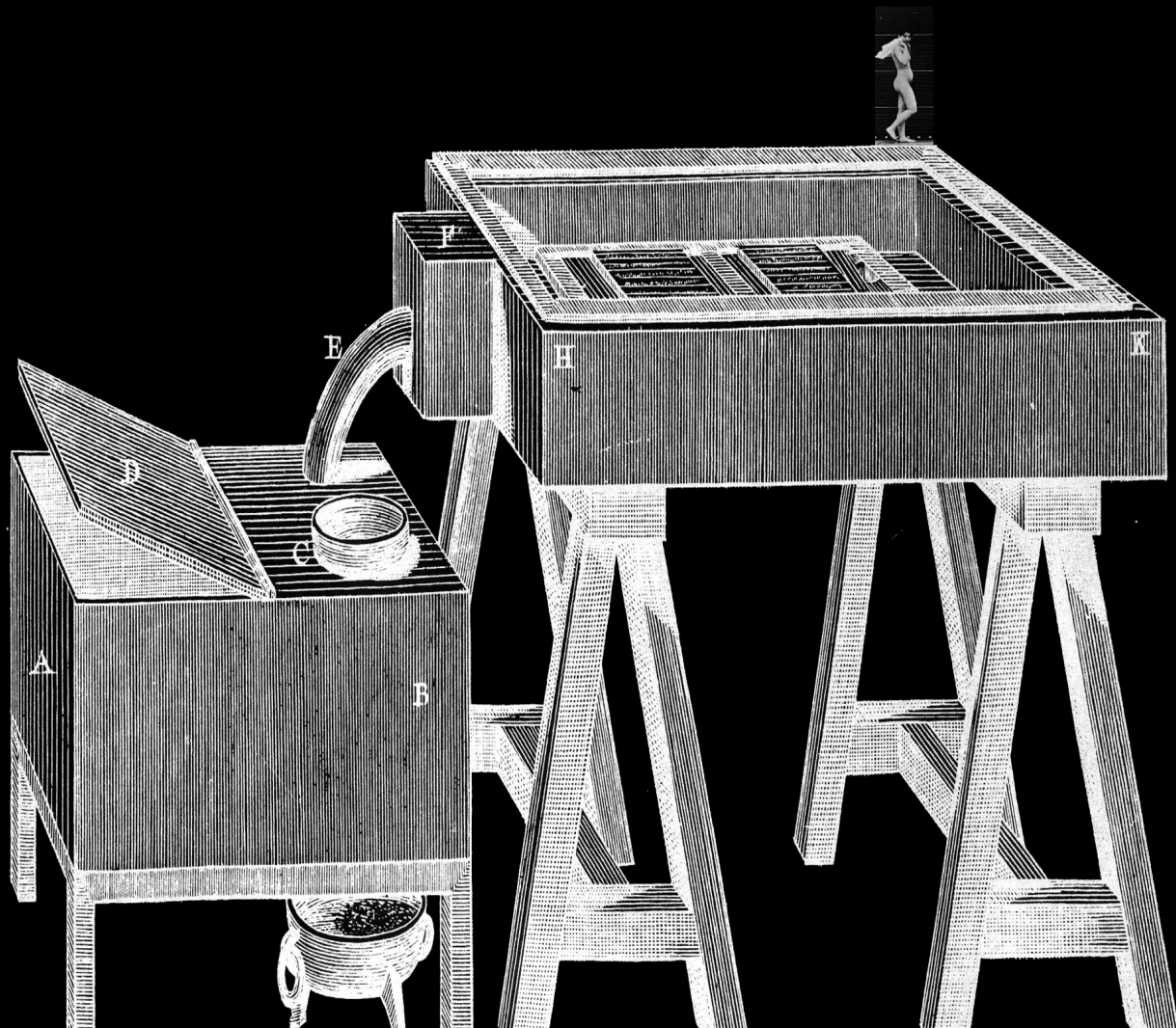




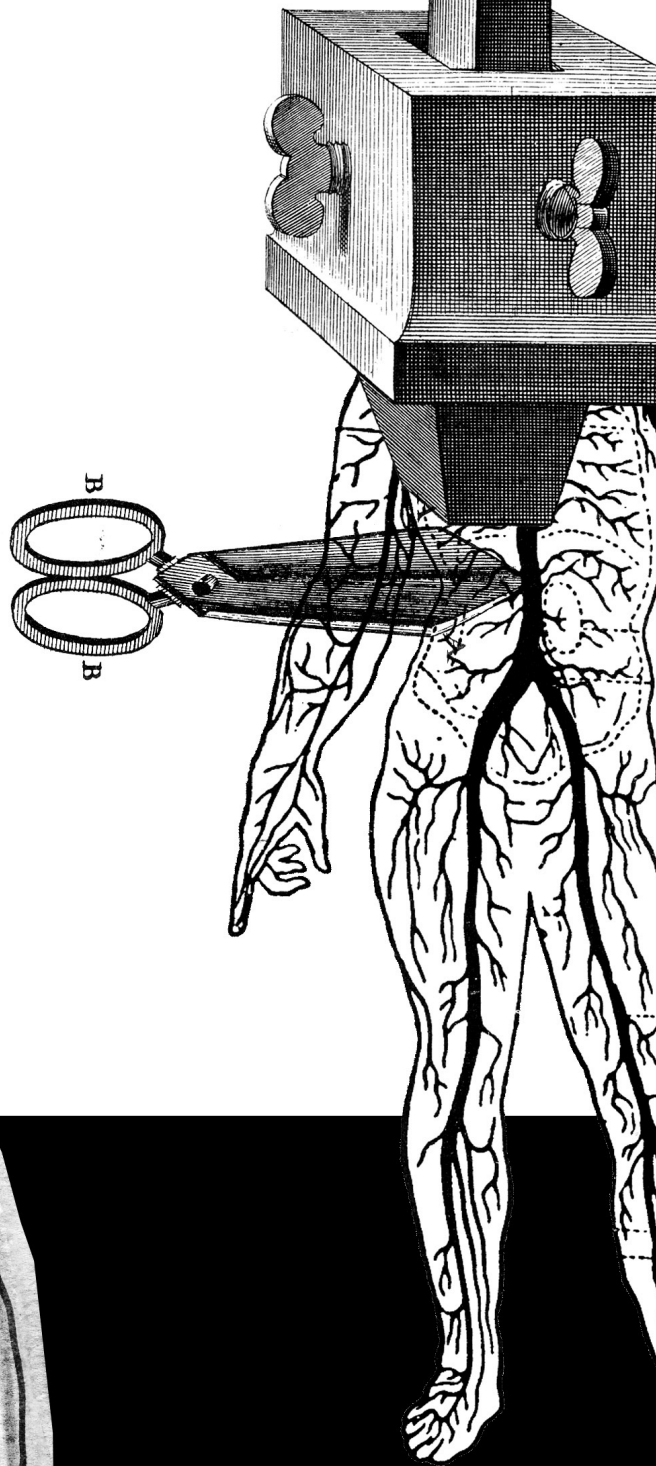
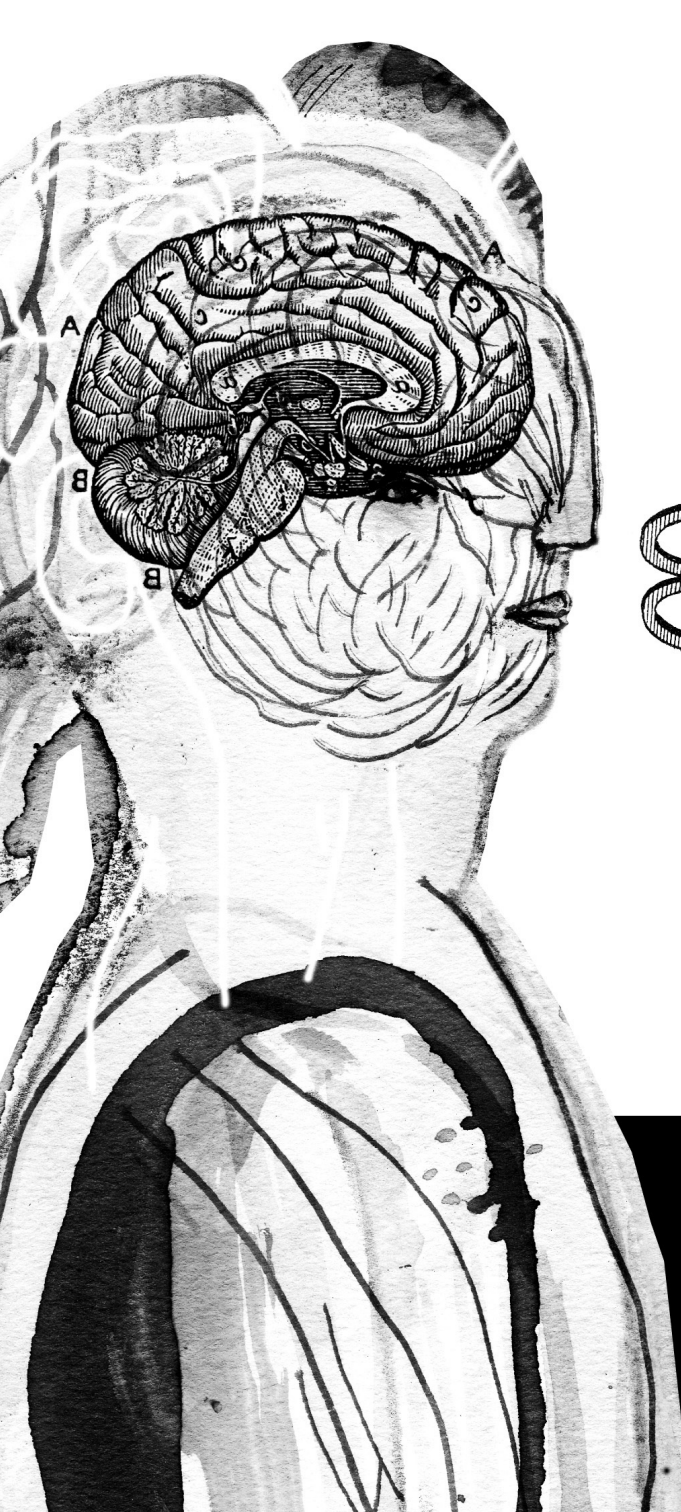


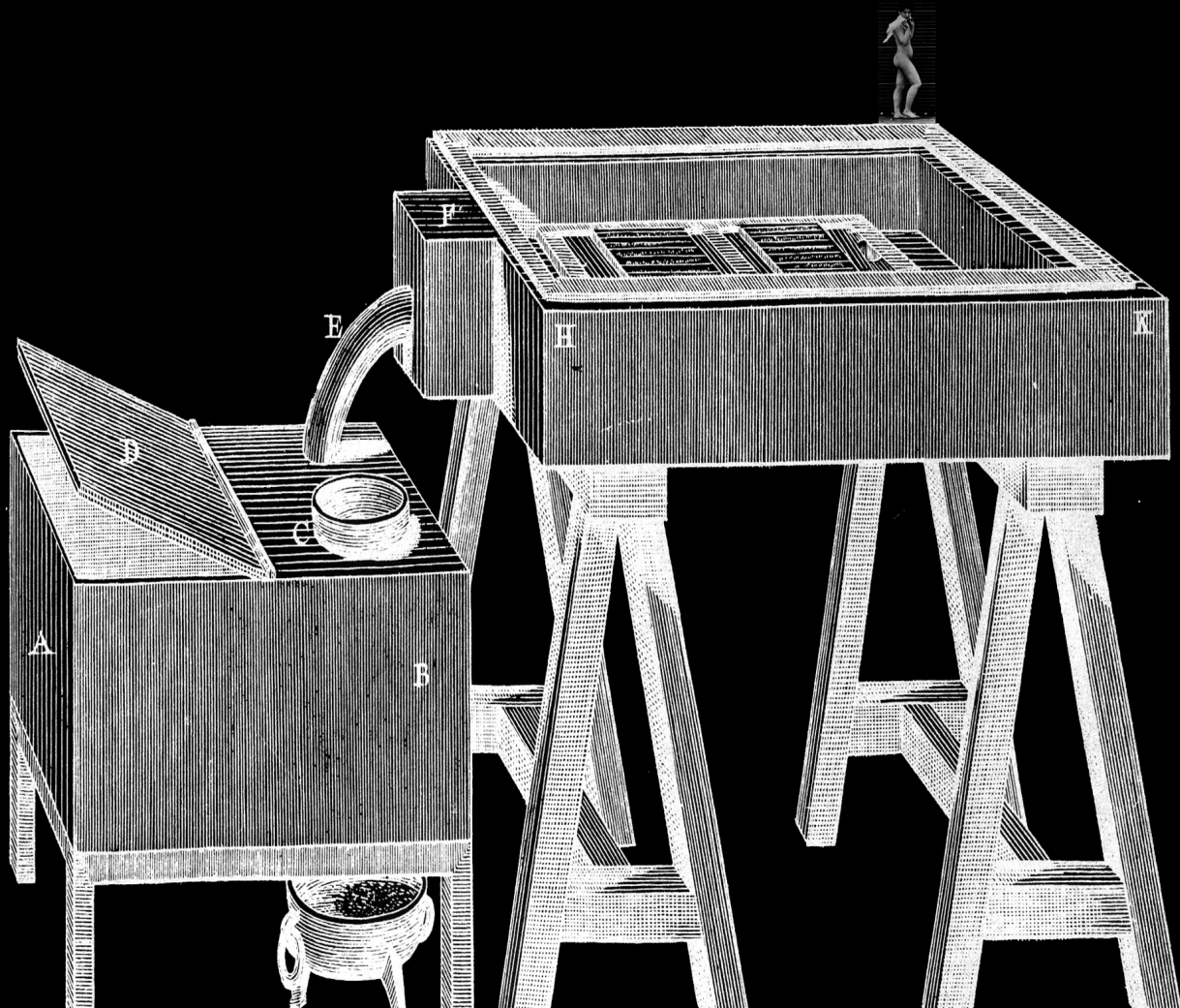


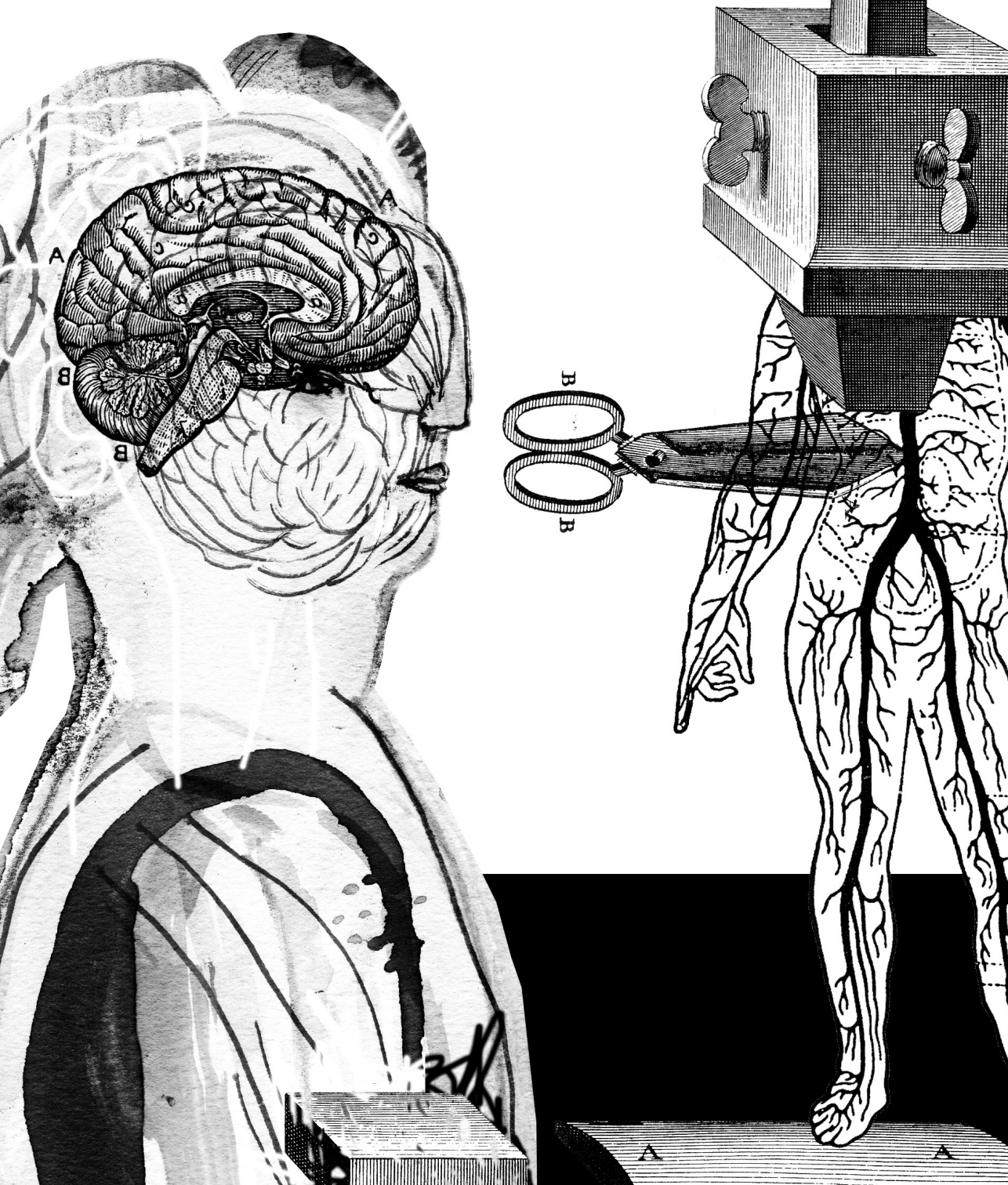


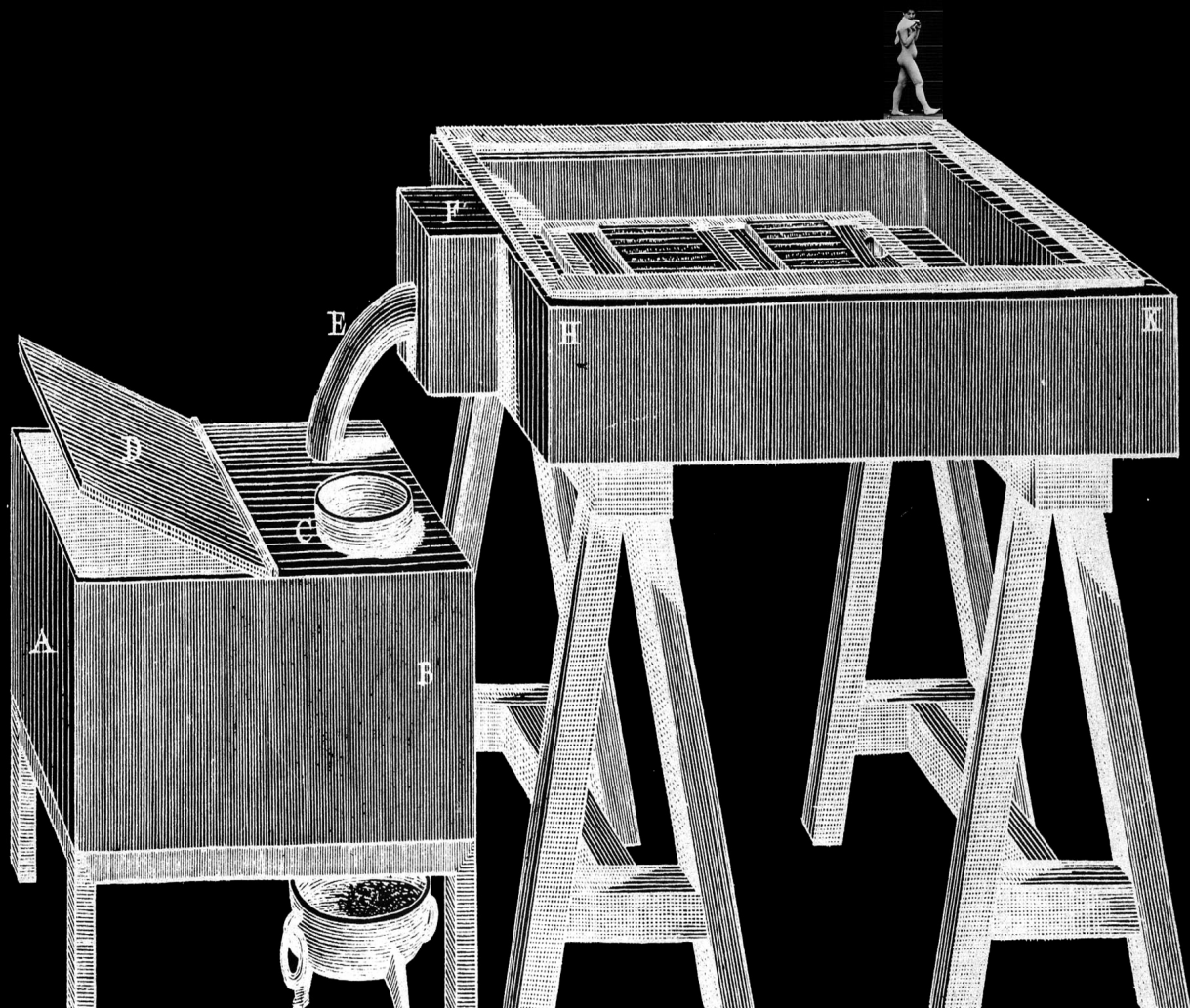


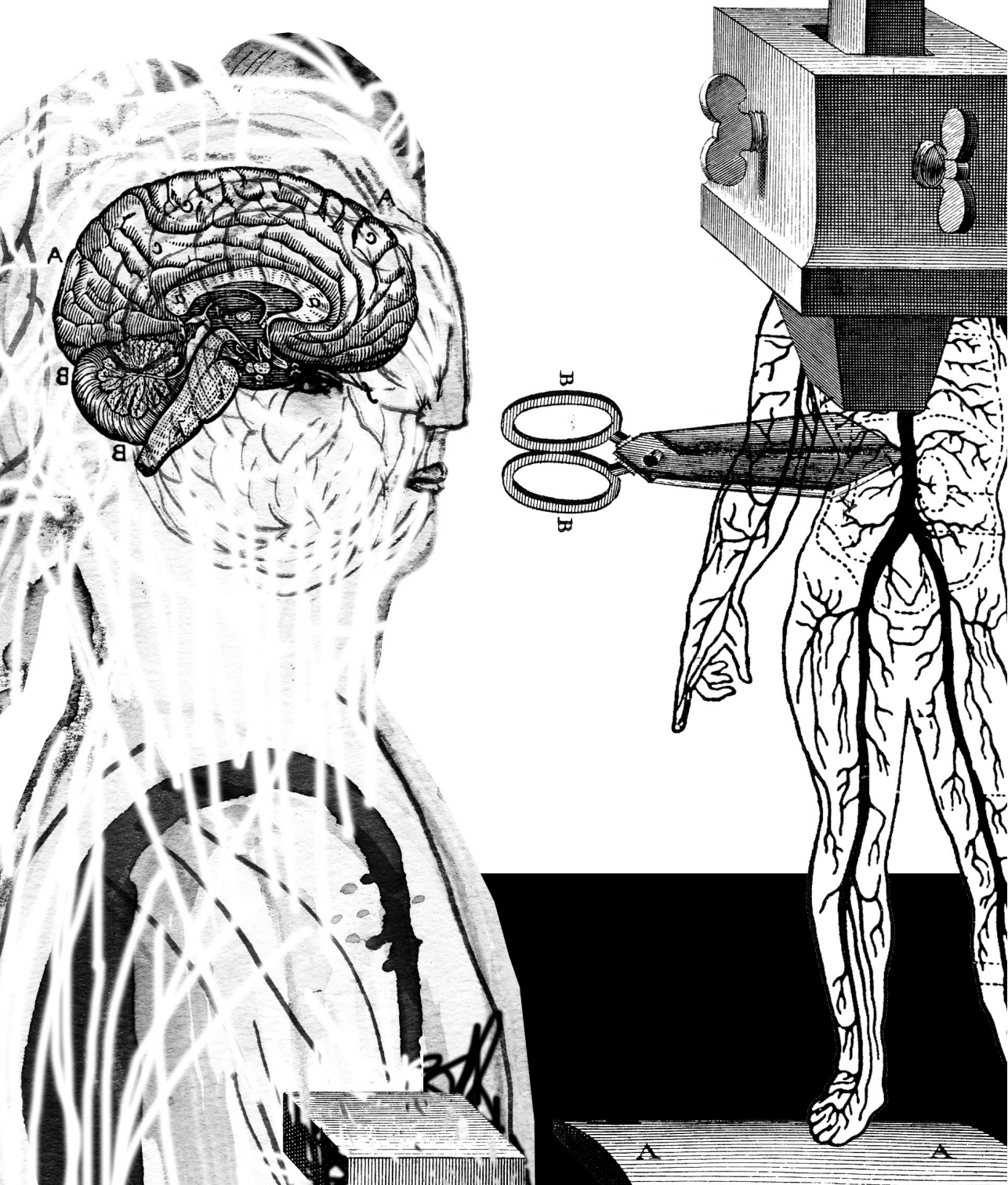


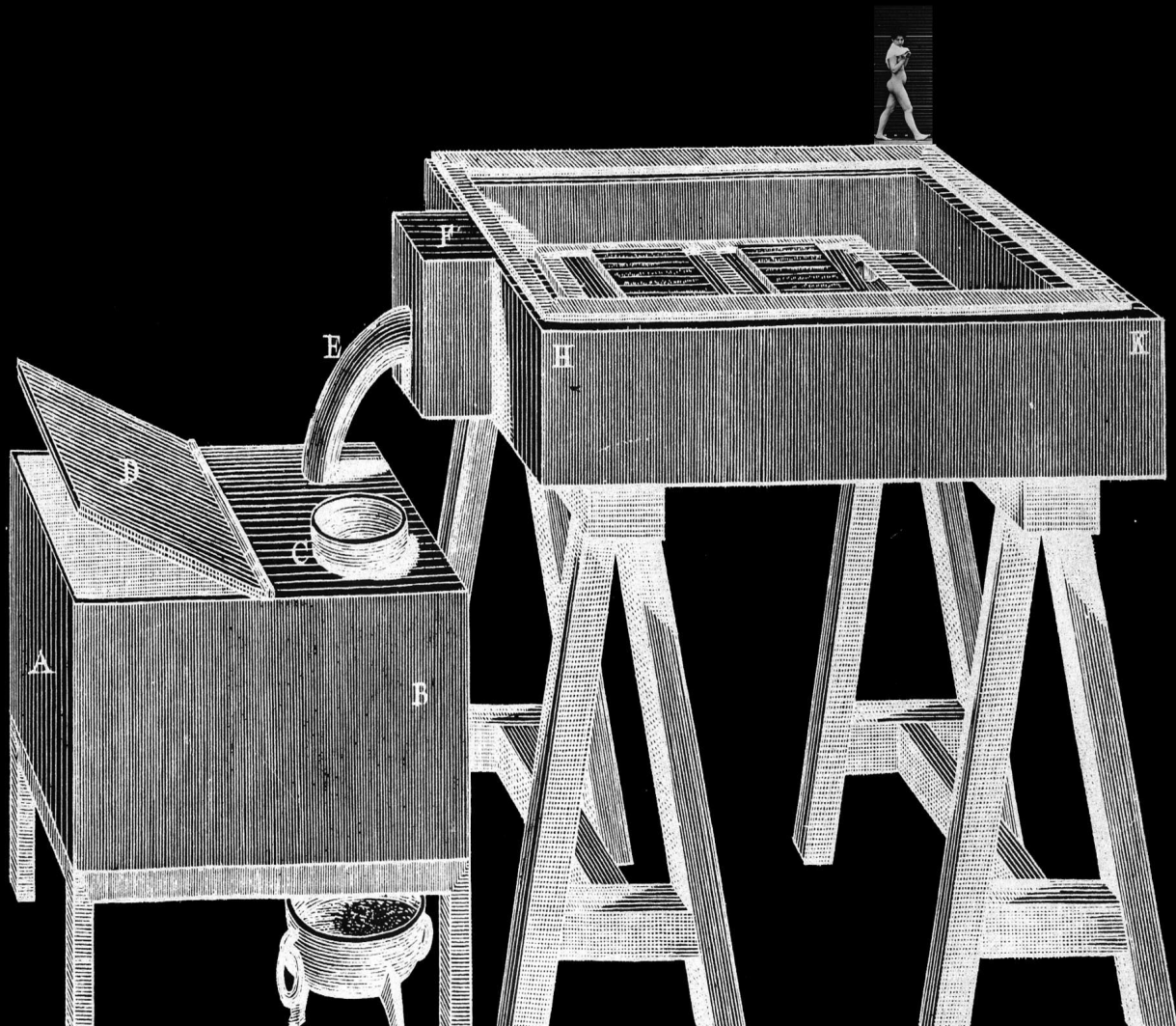












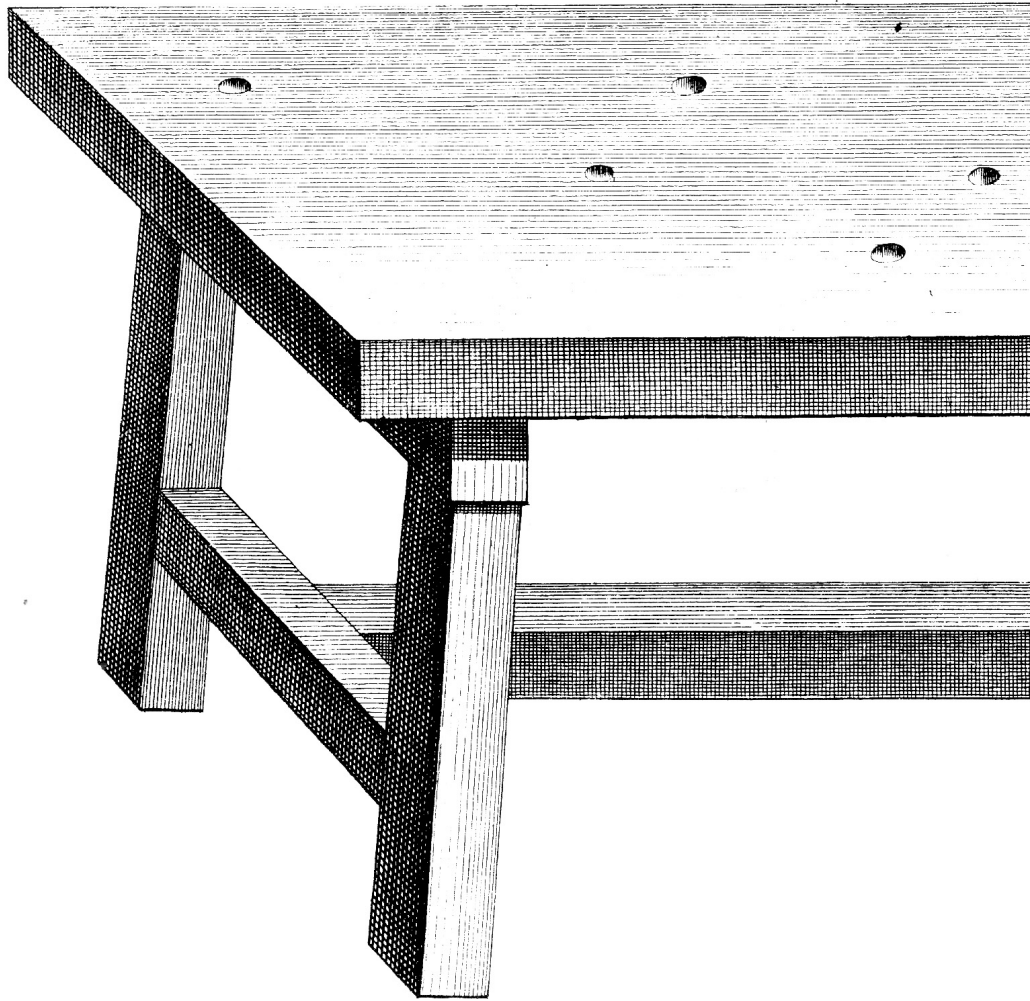


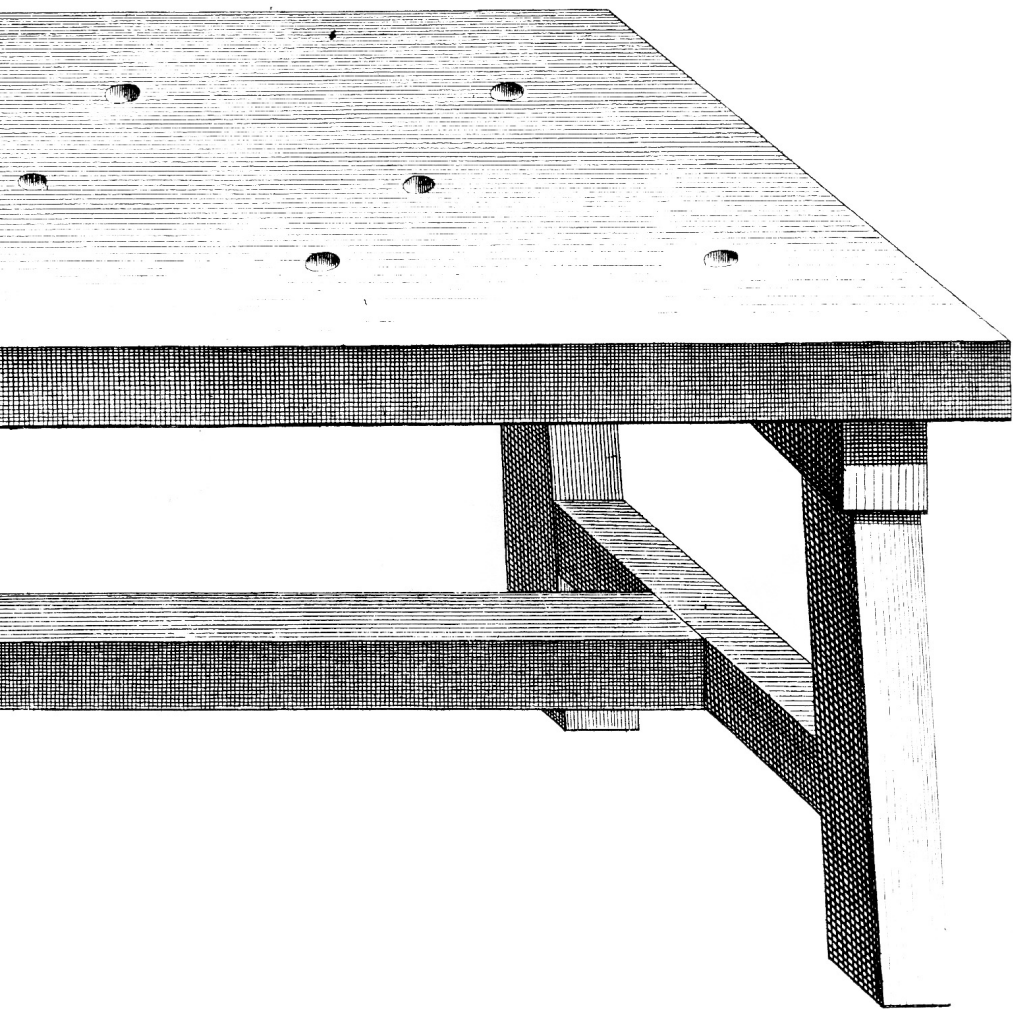


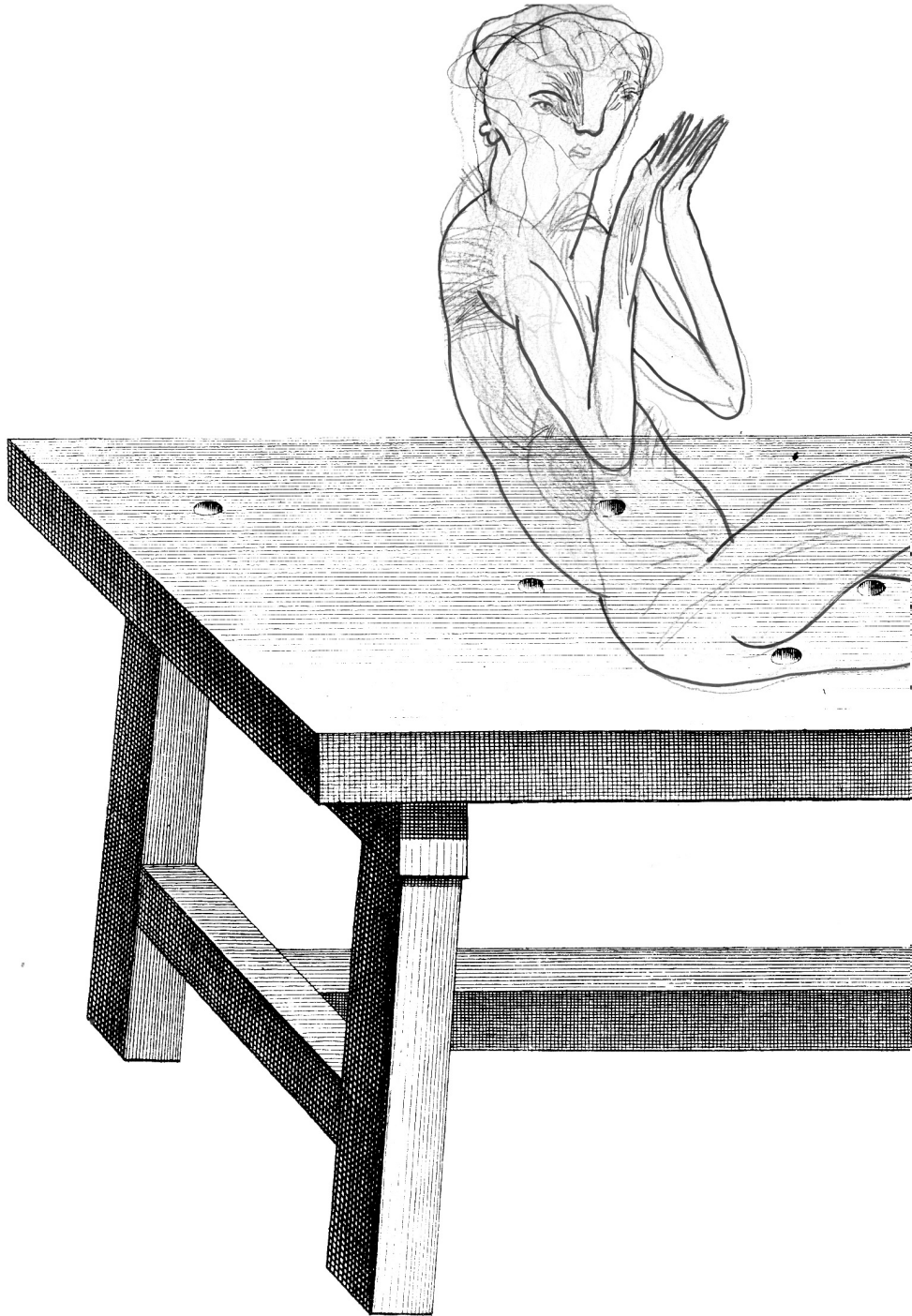


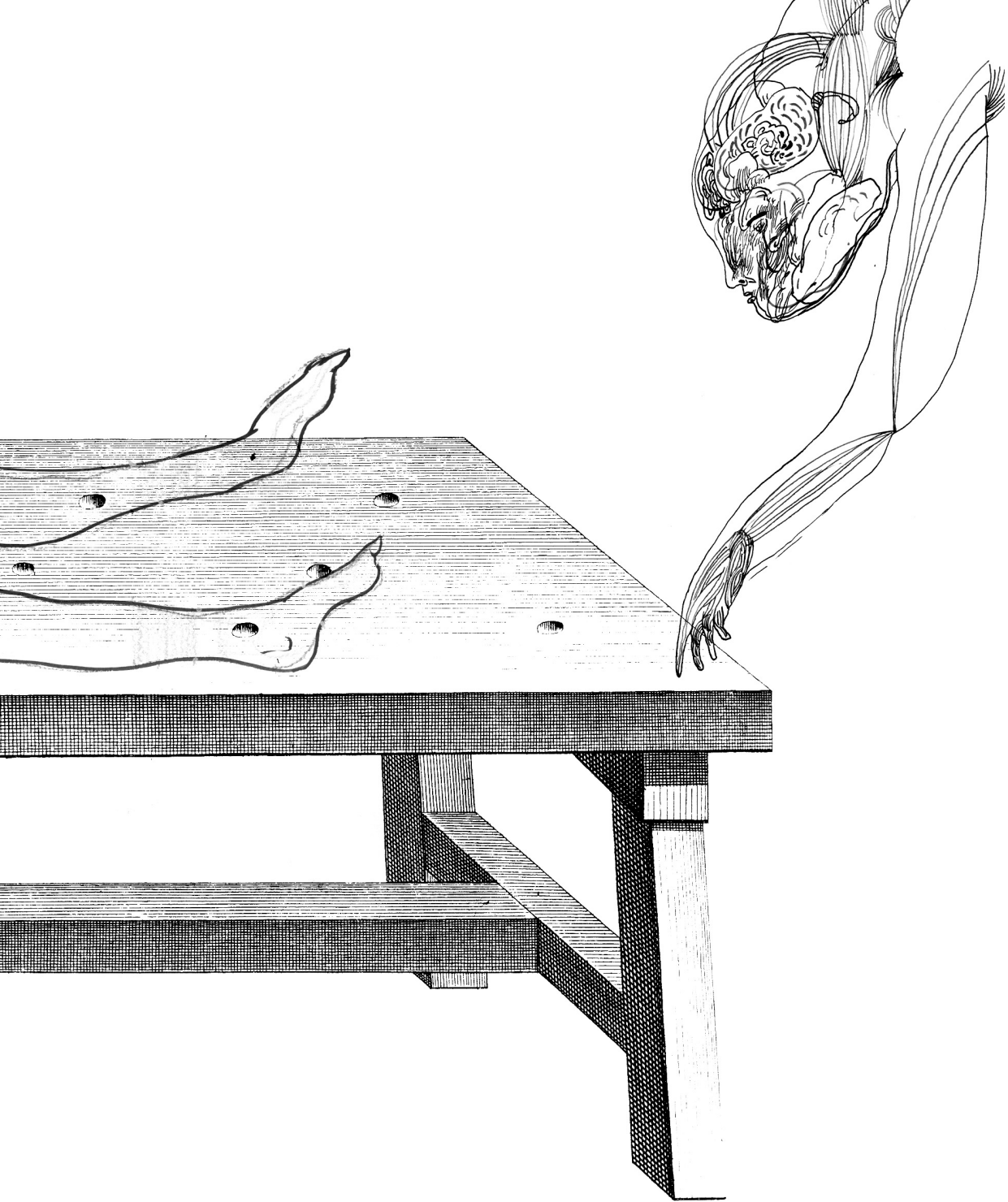








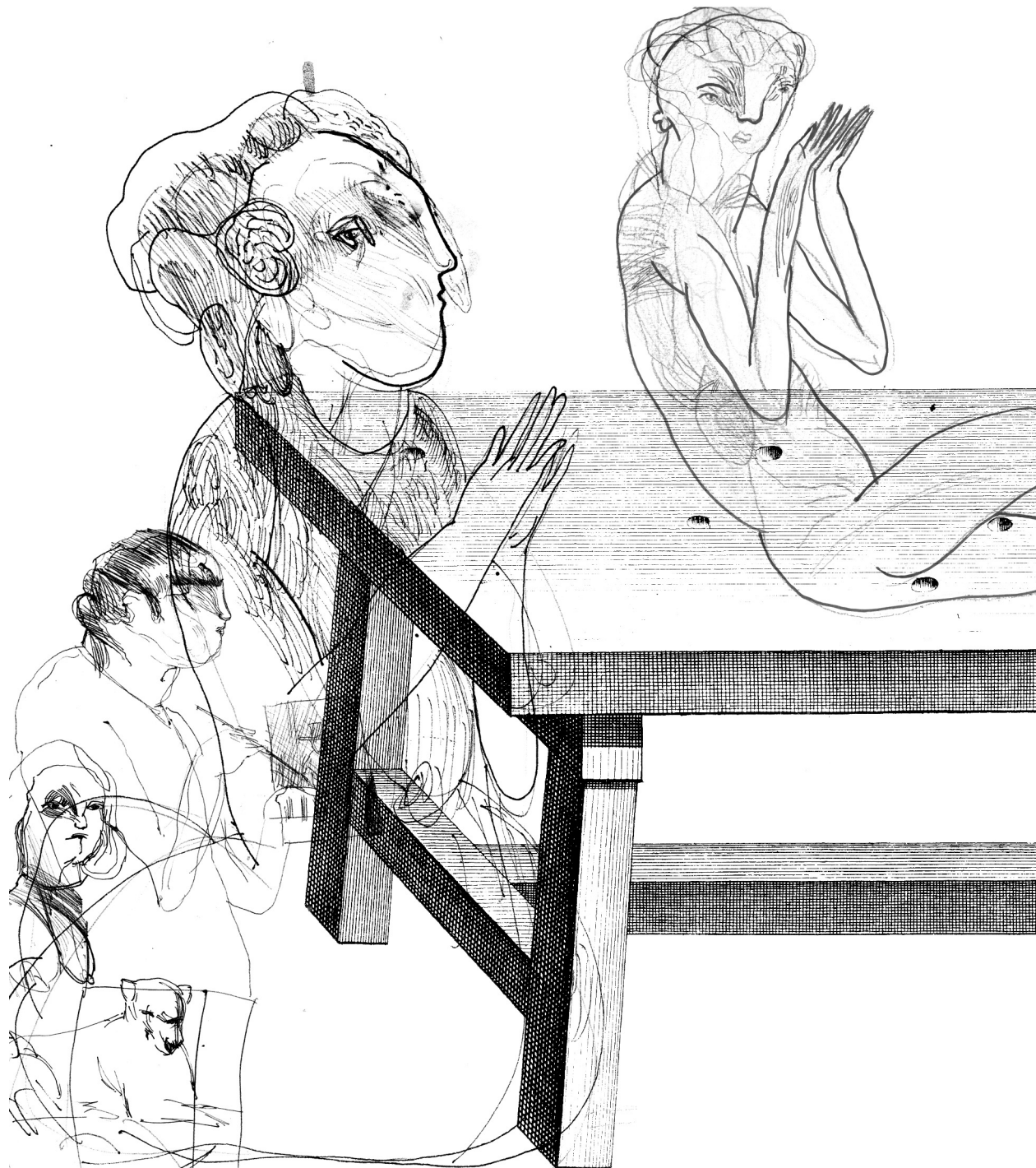




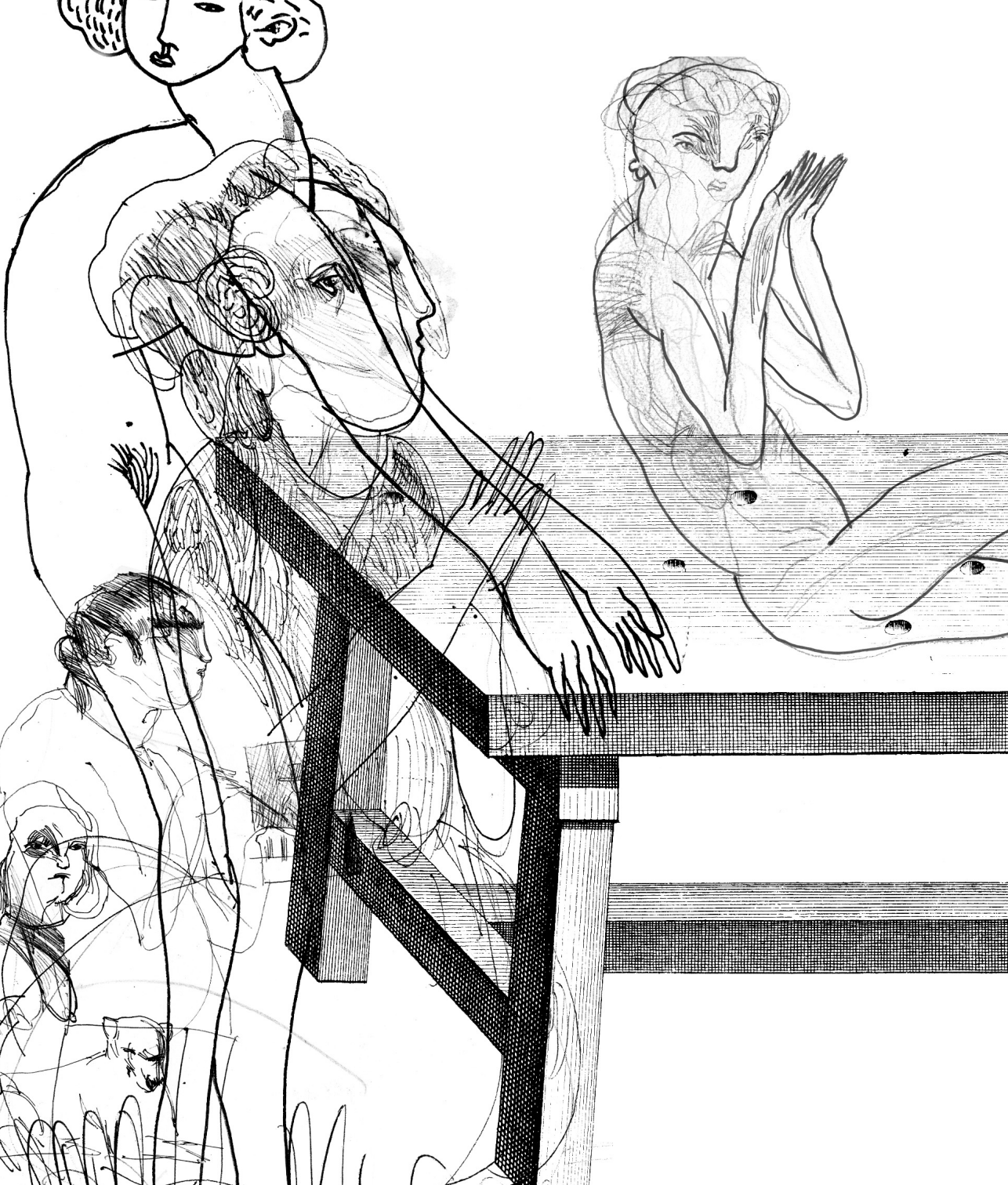






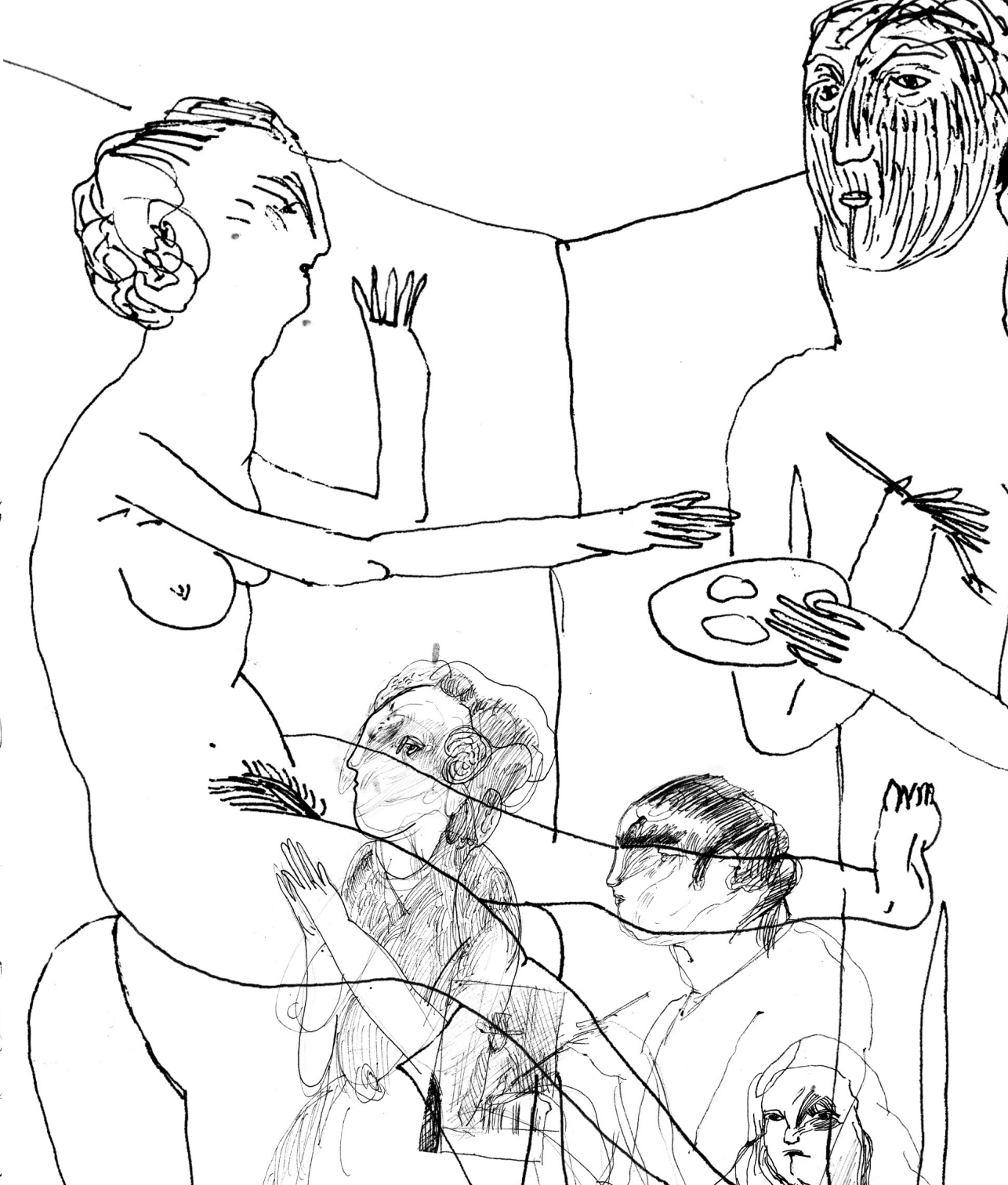




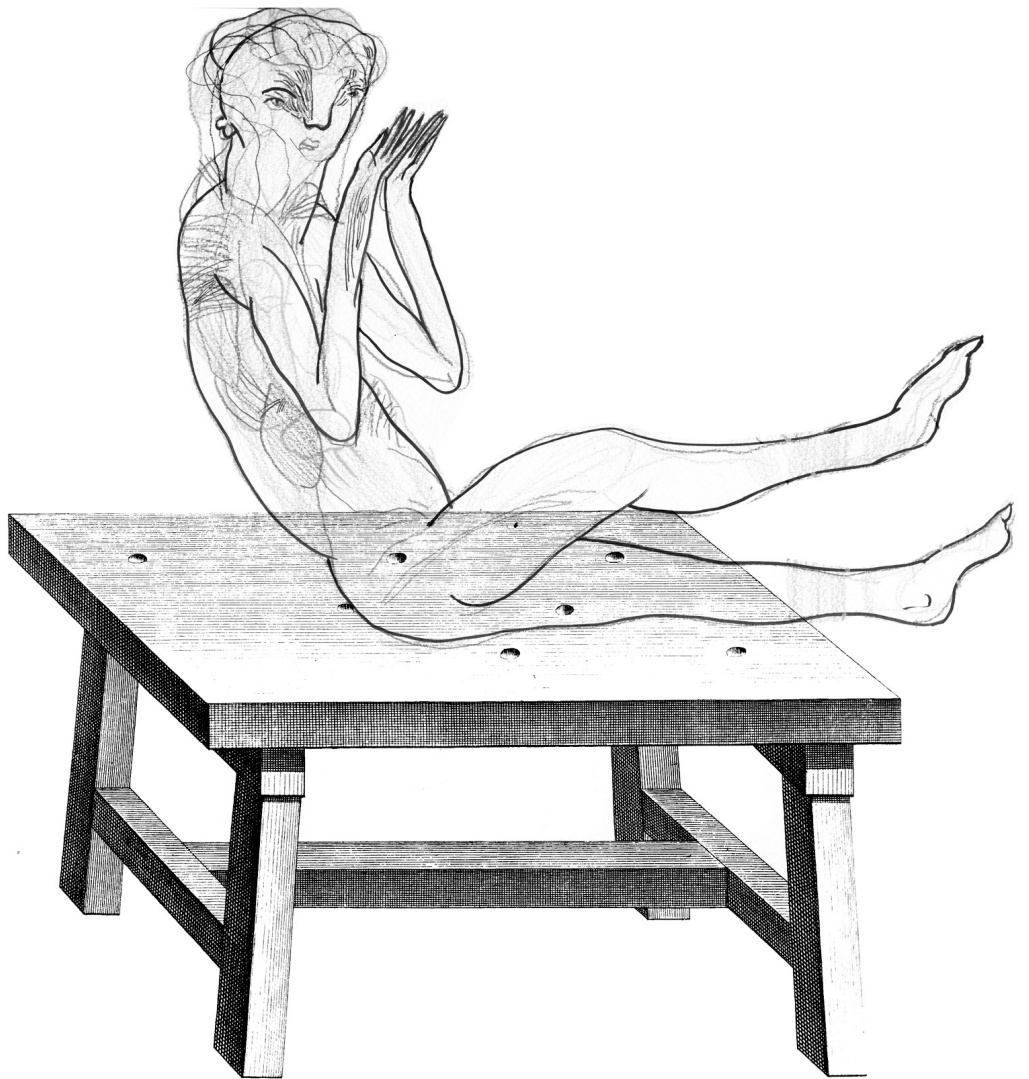












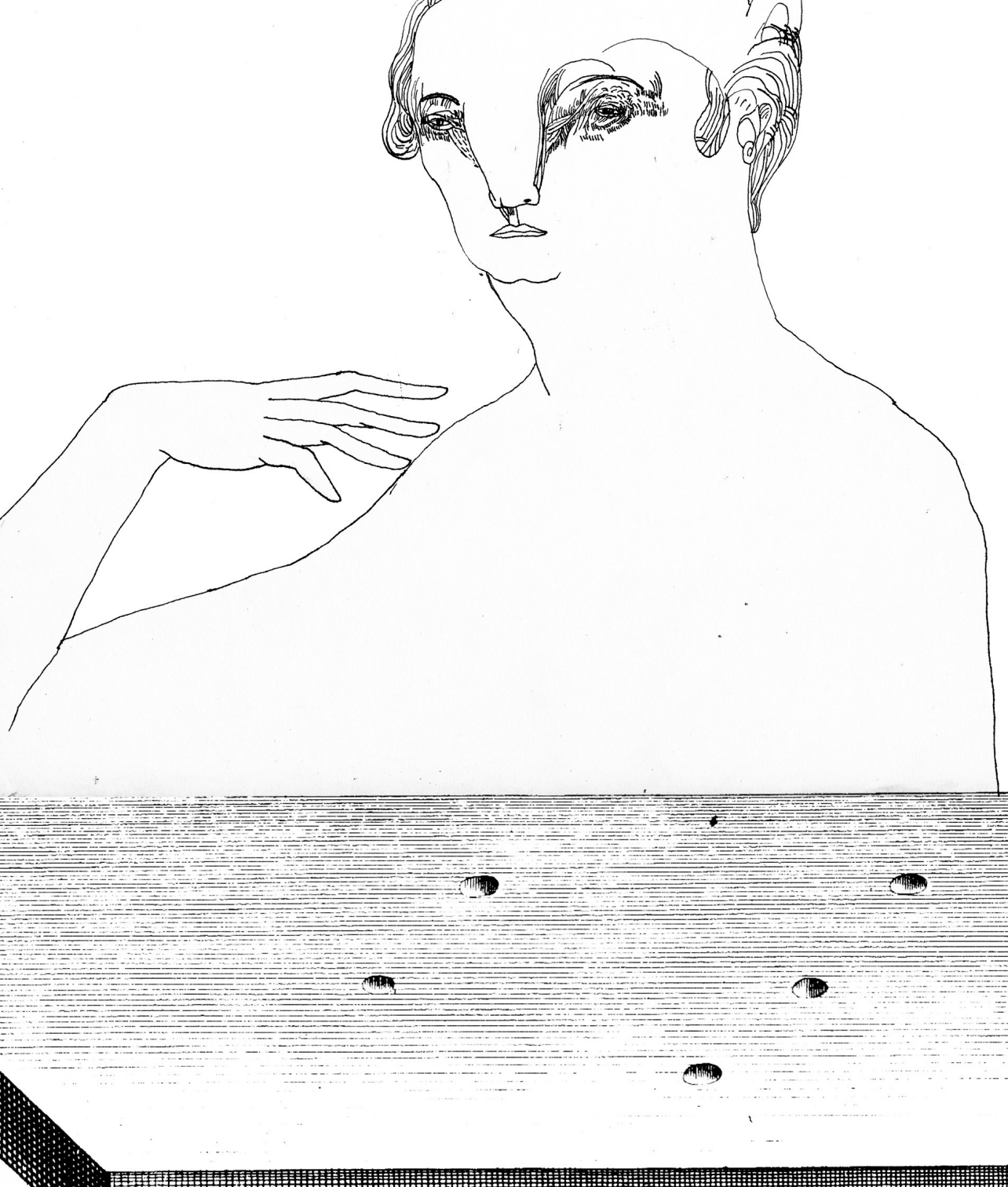


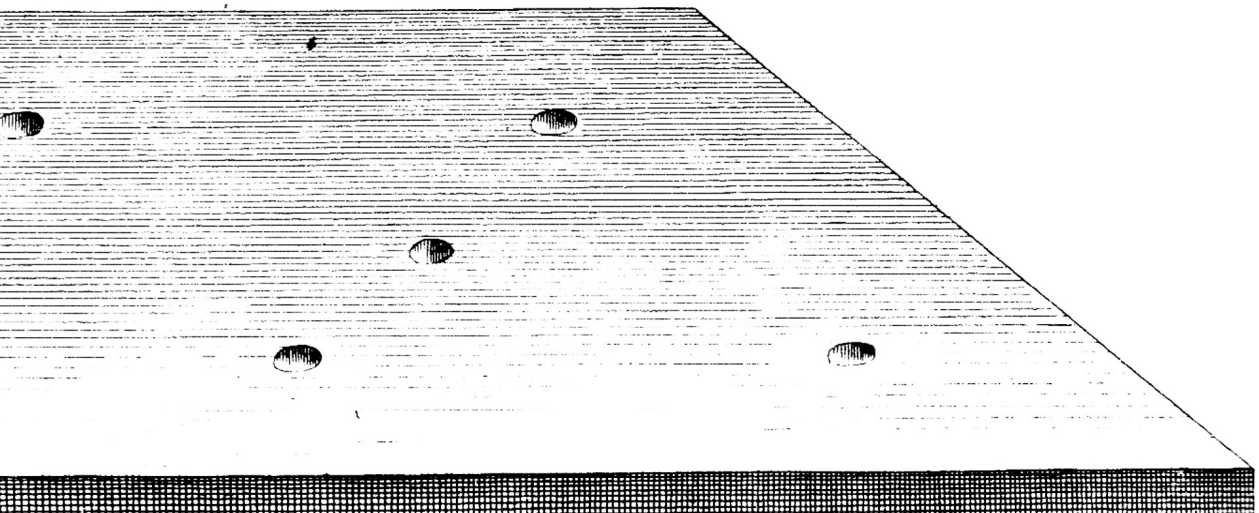






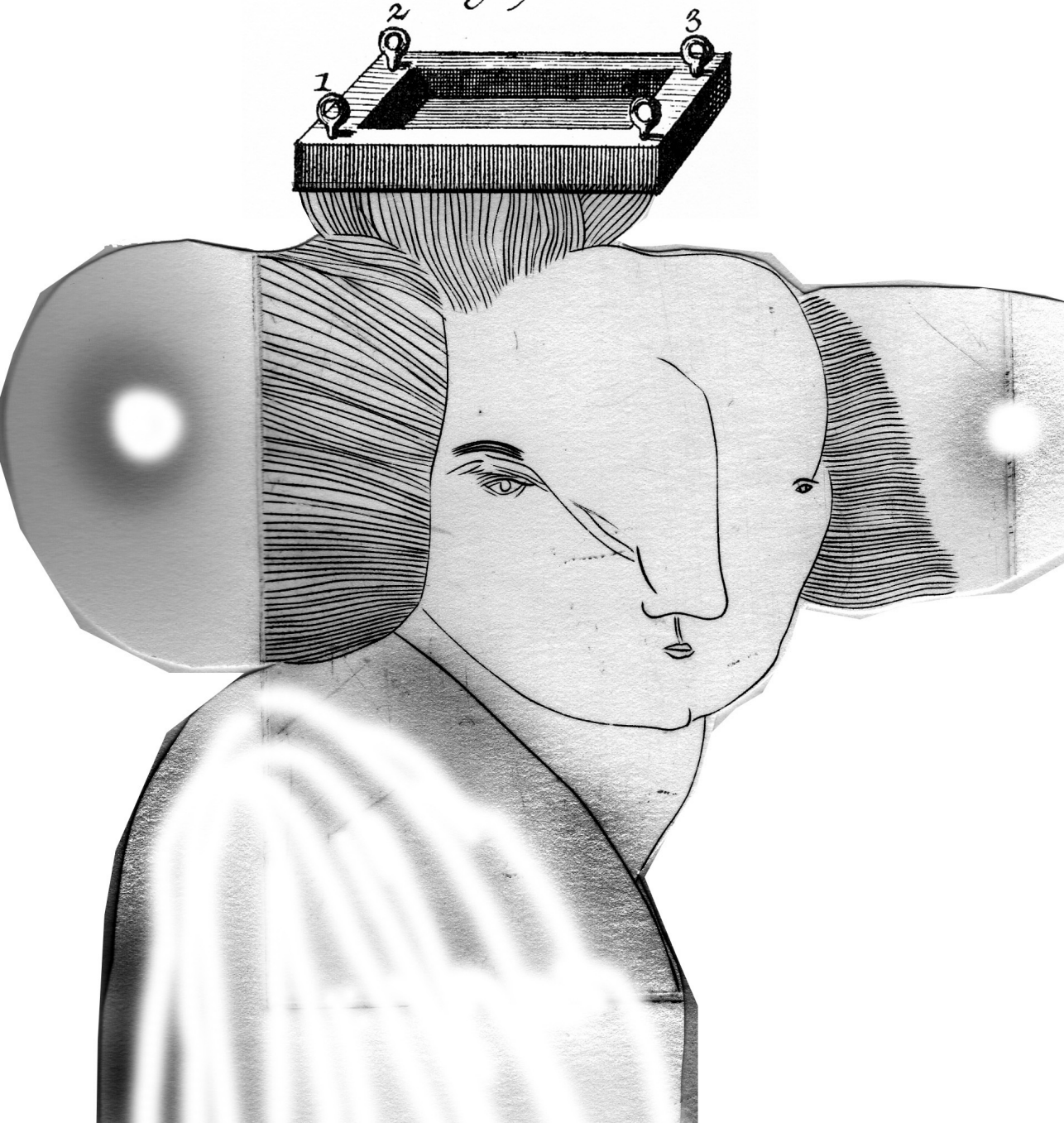








*Fig. 9. N<sup>o</sup> 2.*





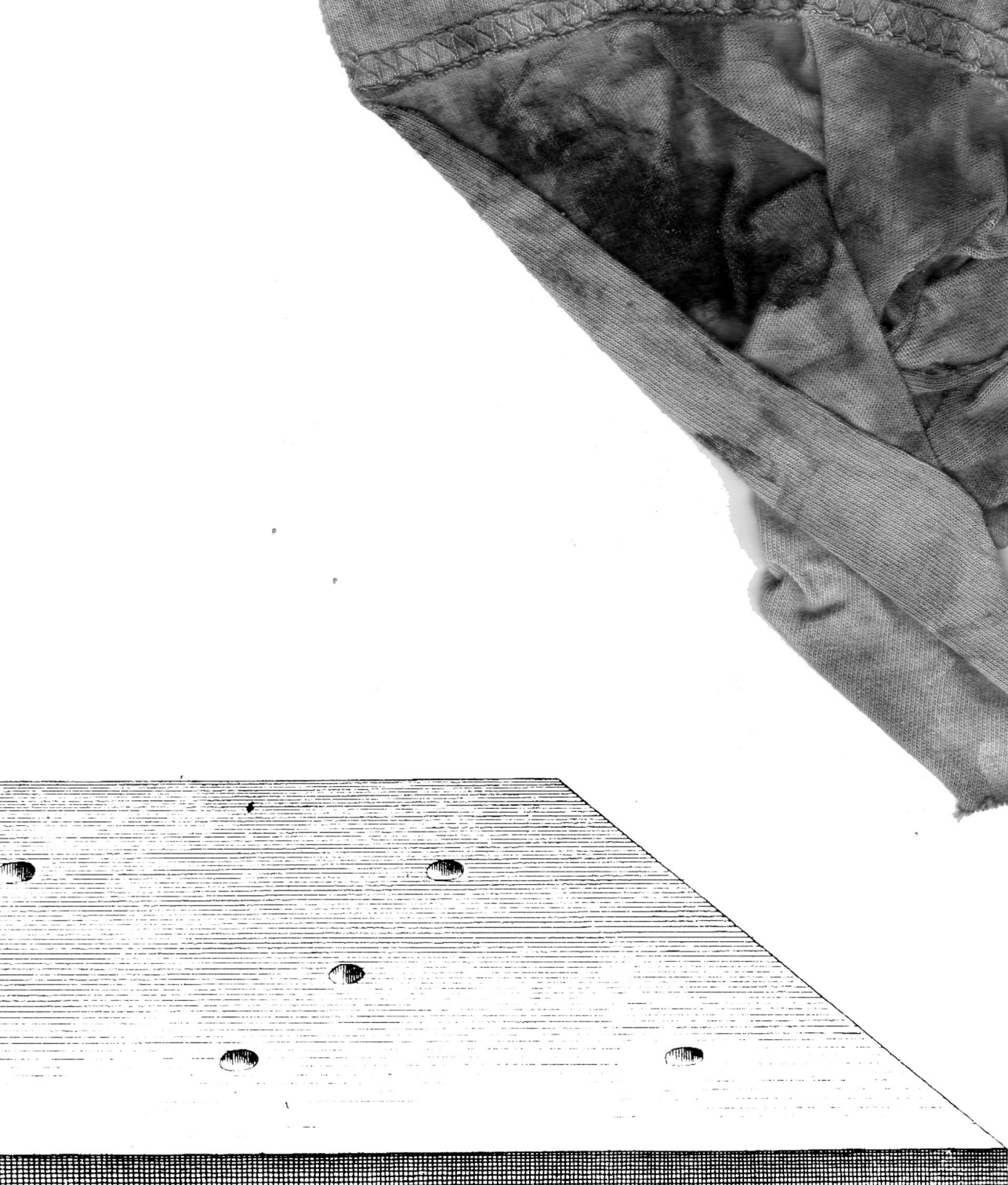








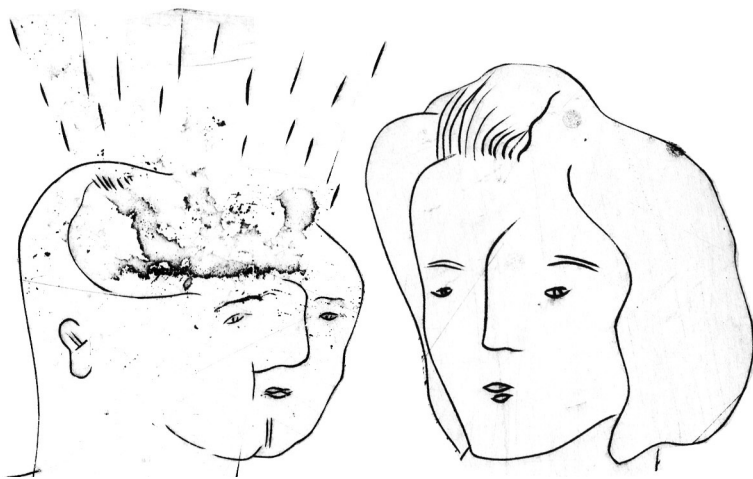
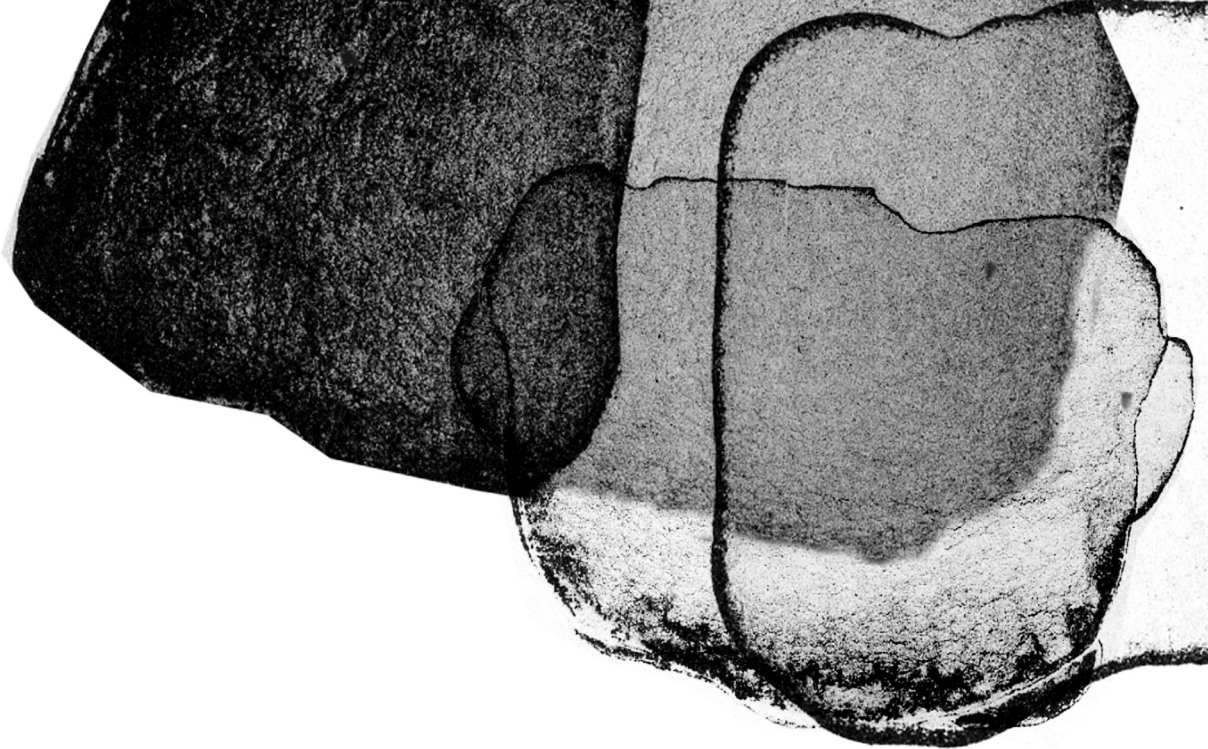


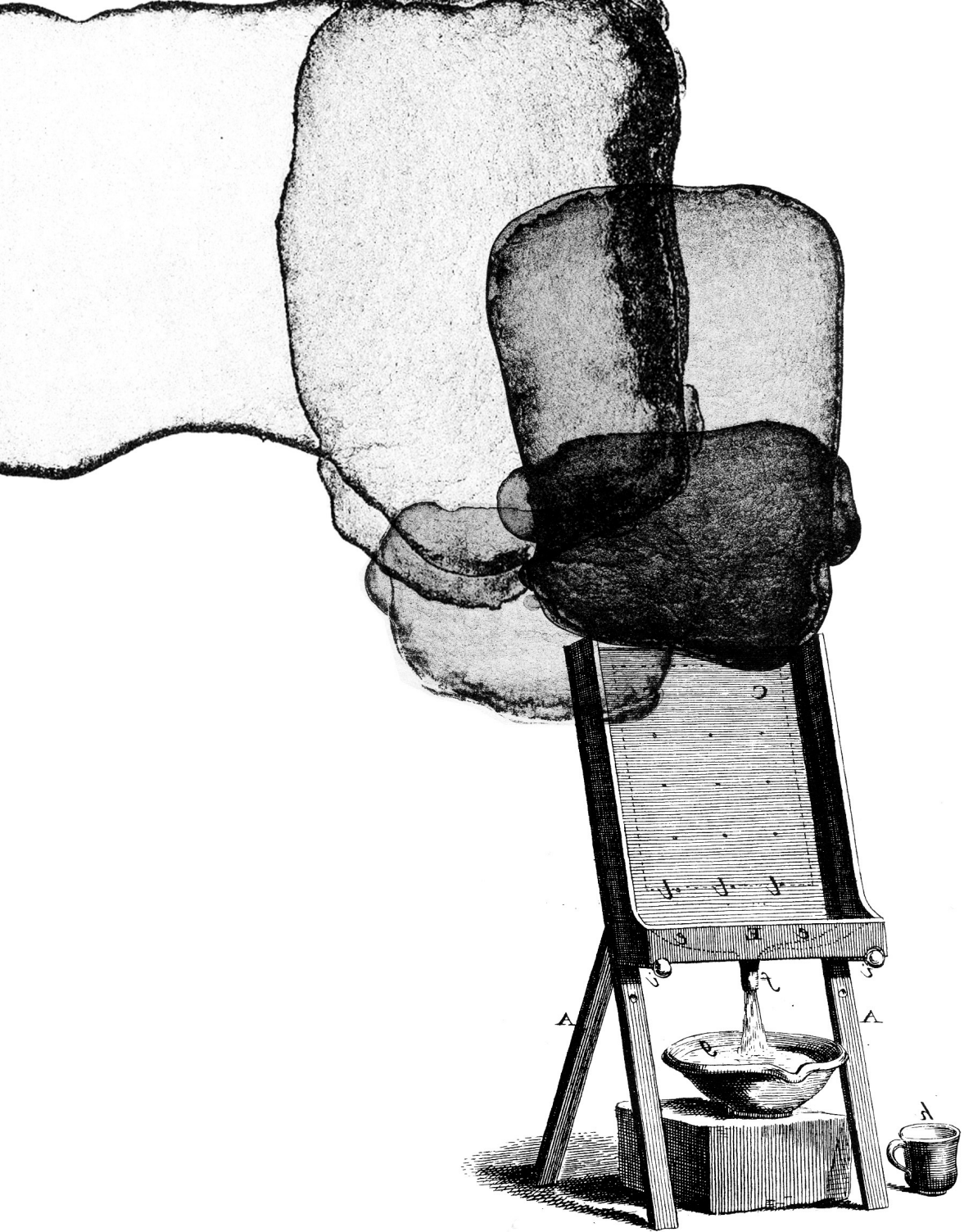


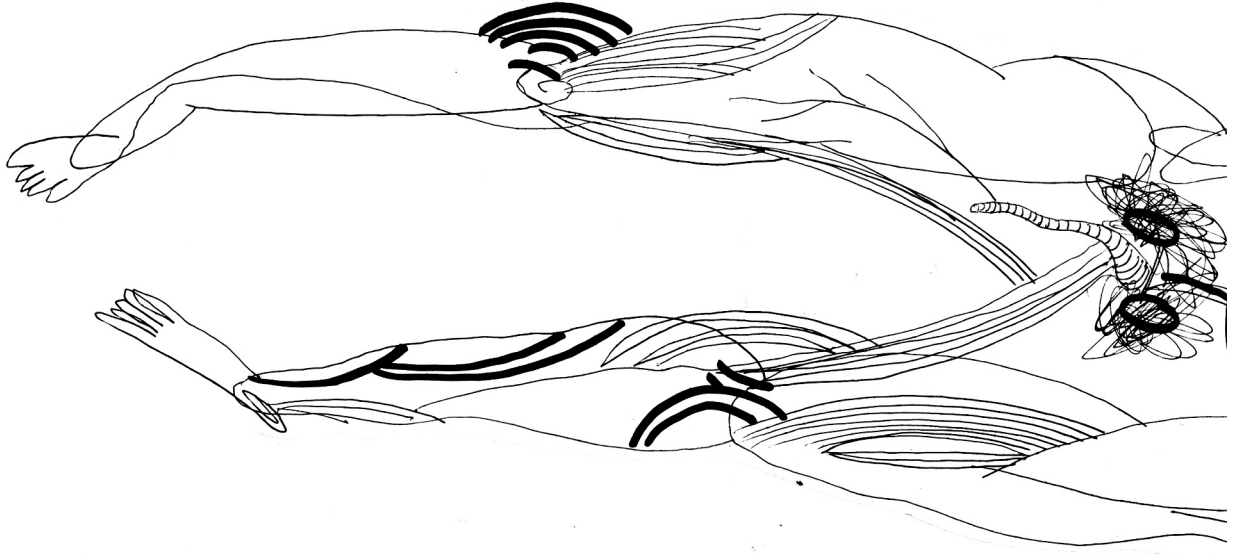




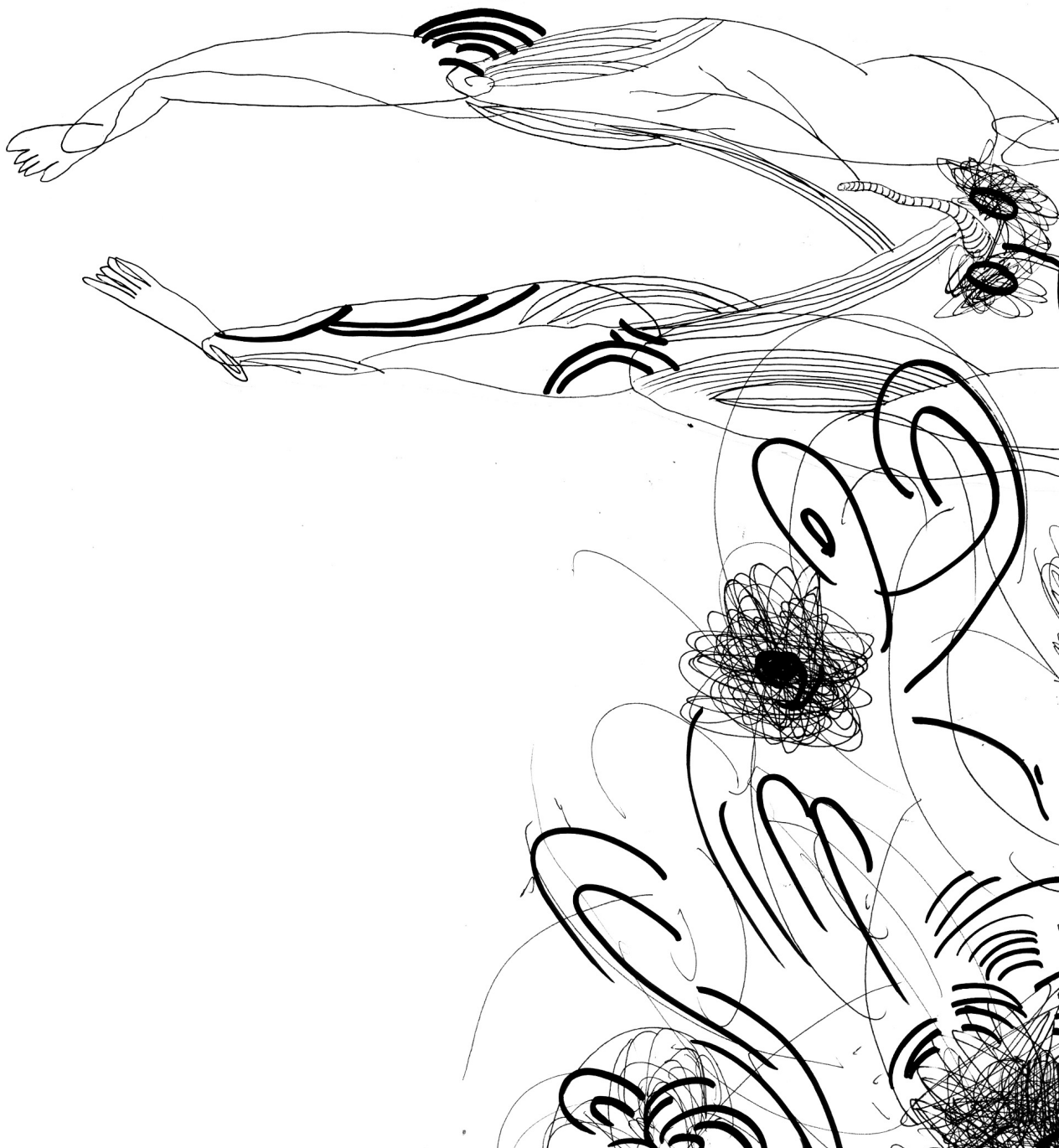












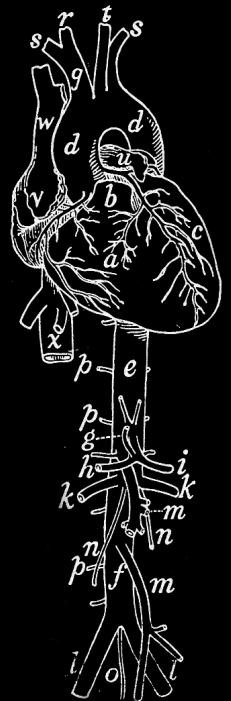
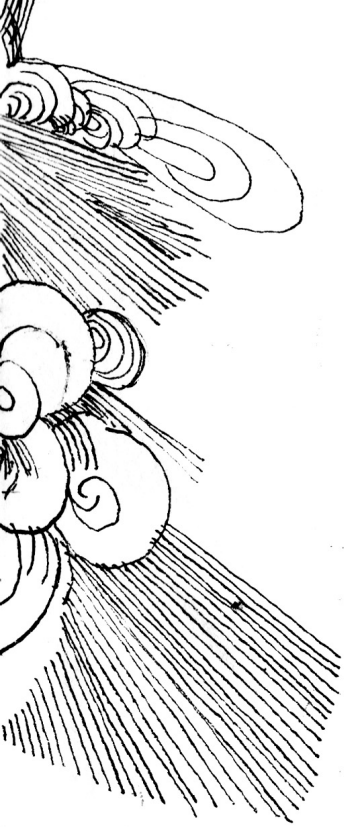


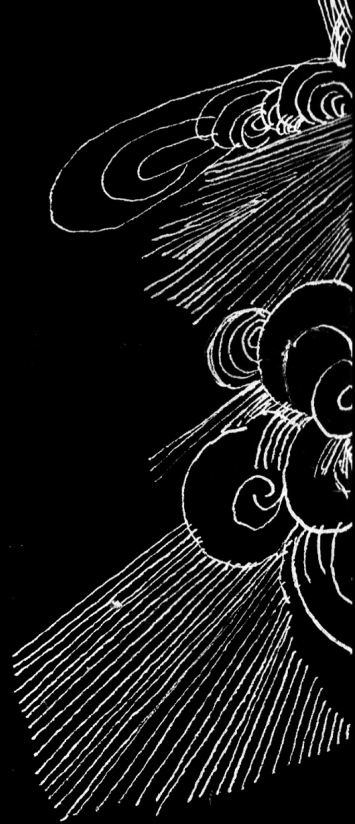


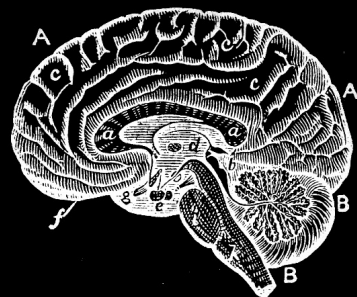
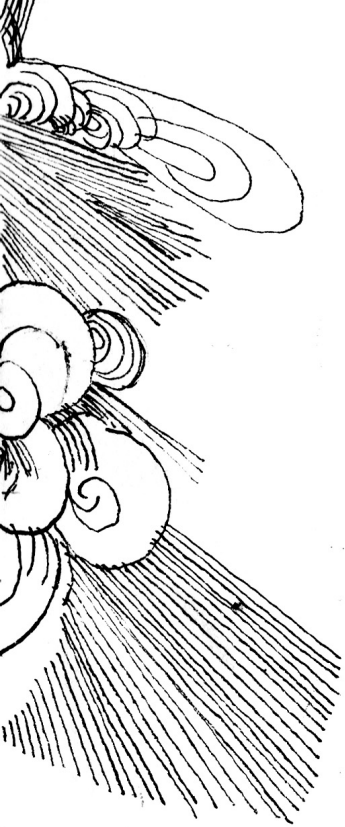












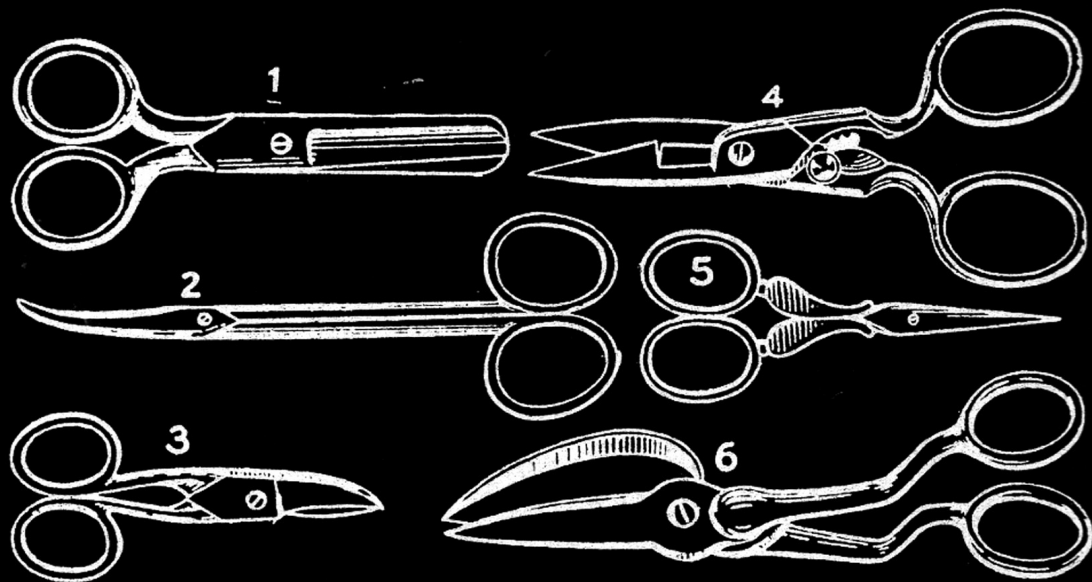
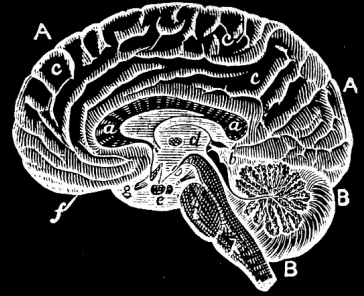
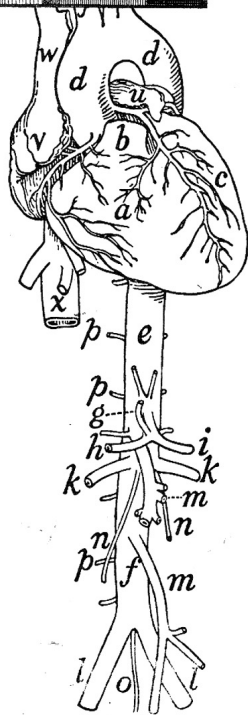
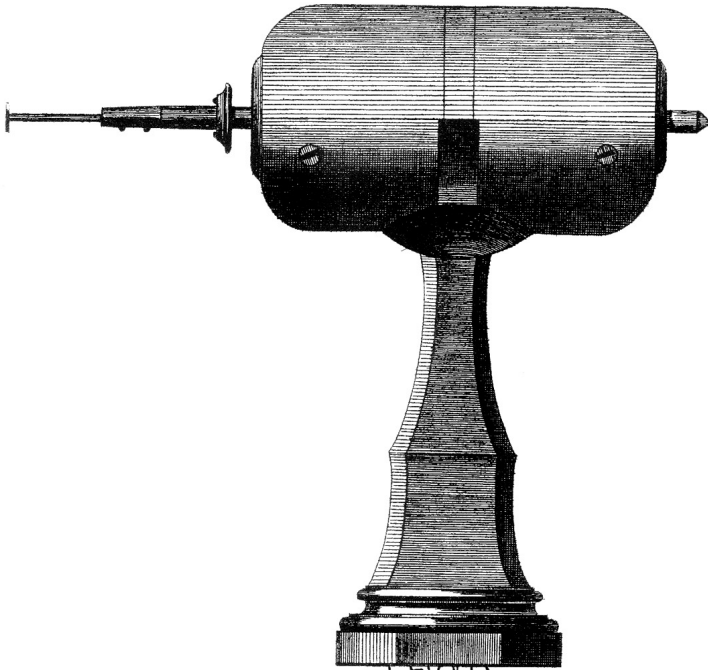
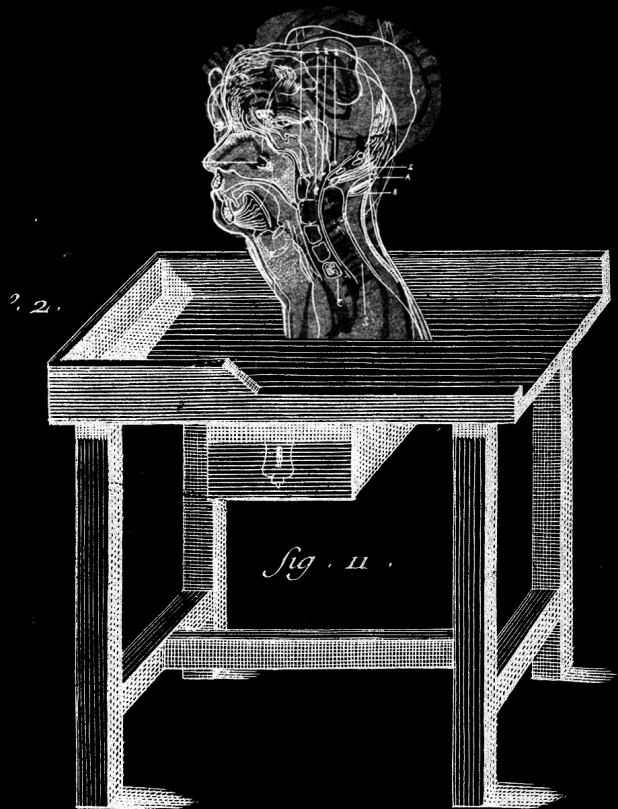


Fig. 1.



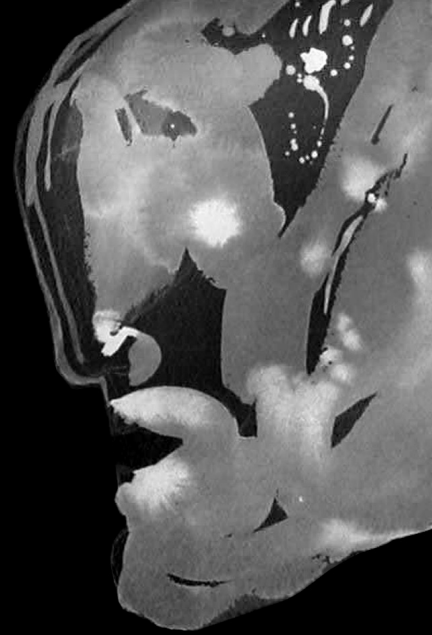


2.

fig. II.



Fig. II.







2. 2.

*fig. 11.*

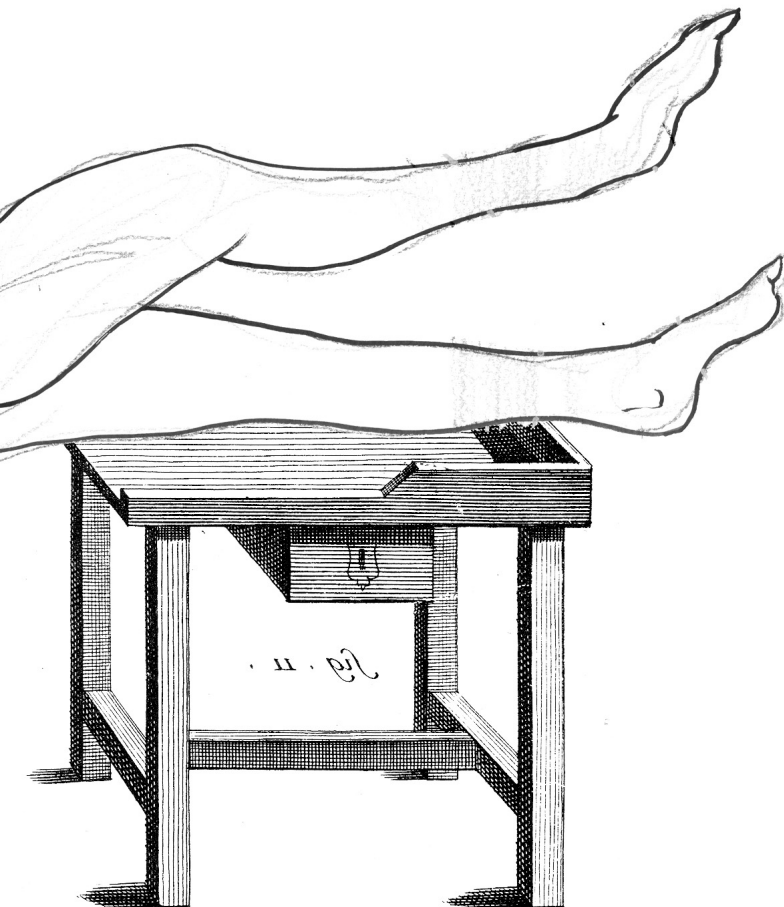
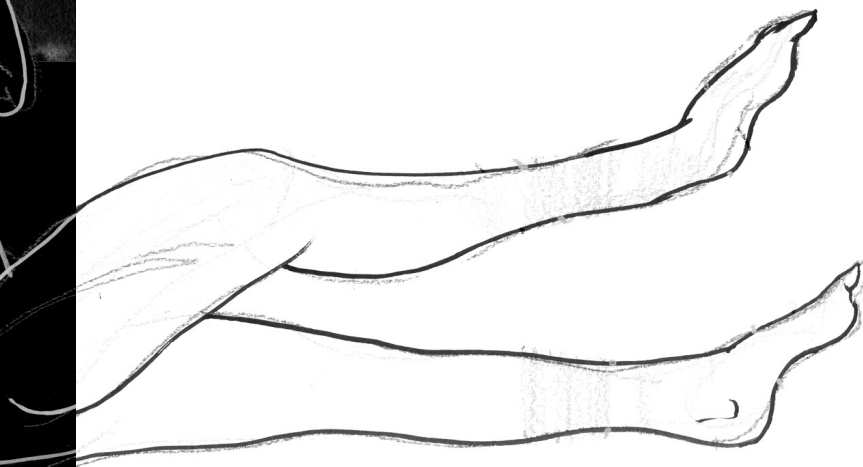
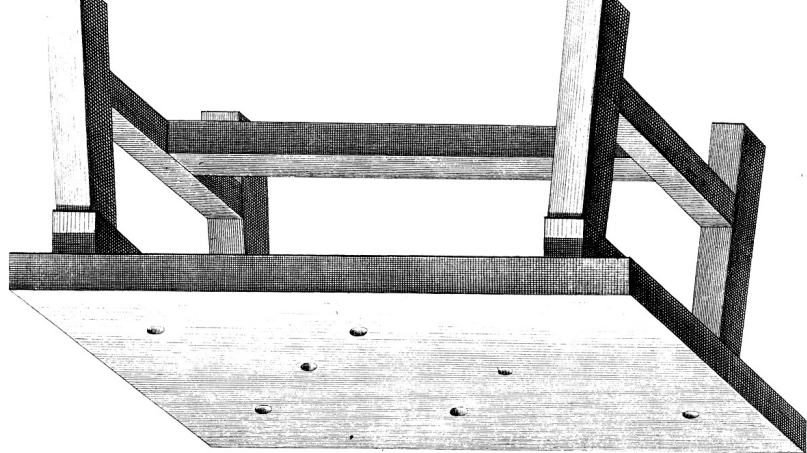
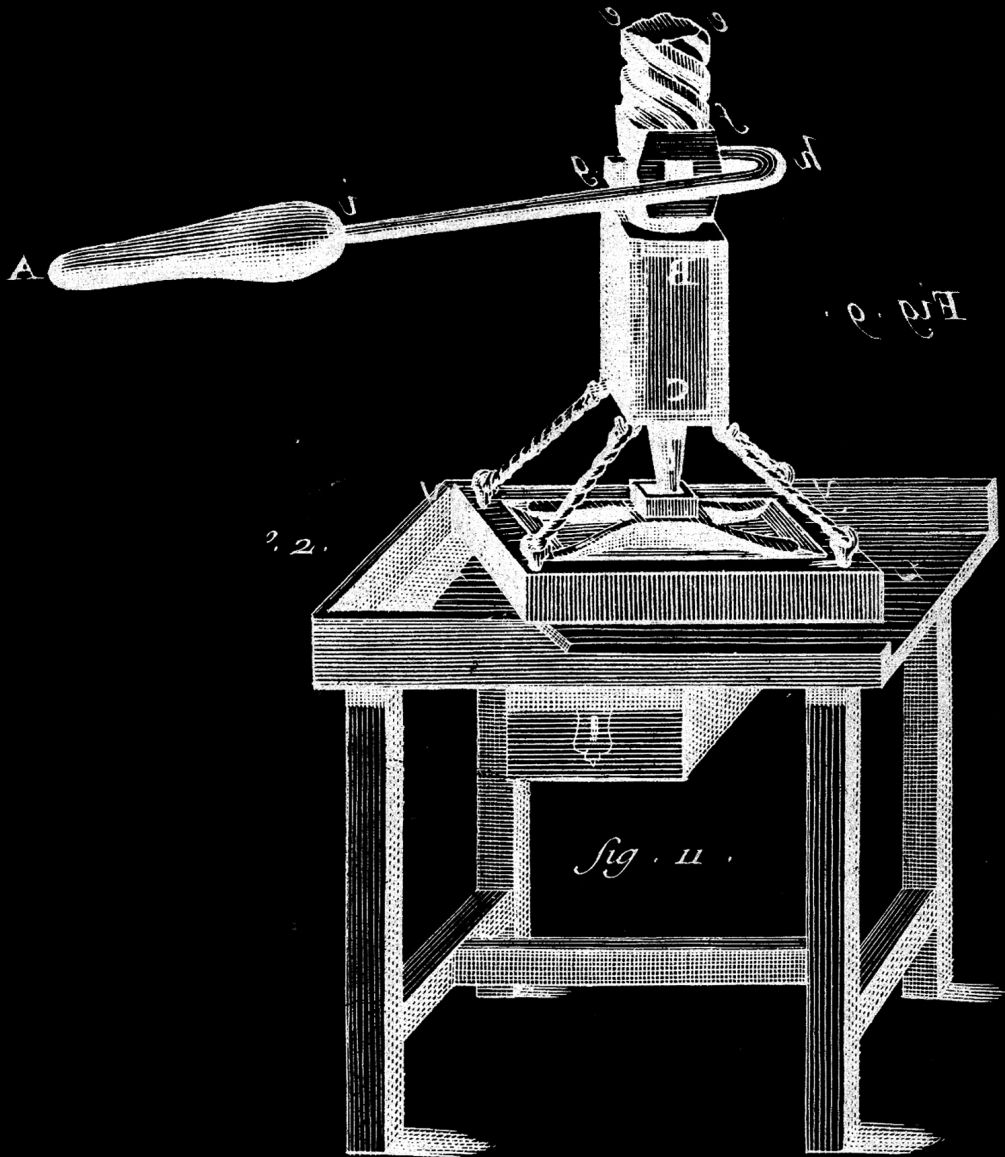


Fig. 15.







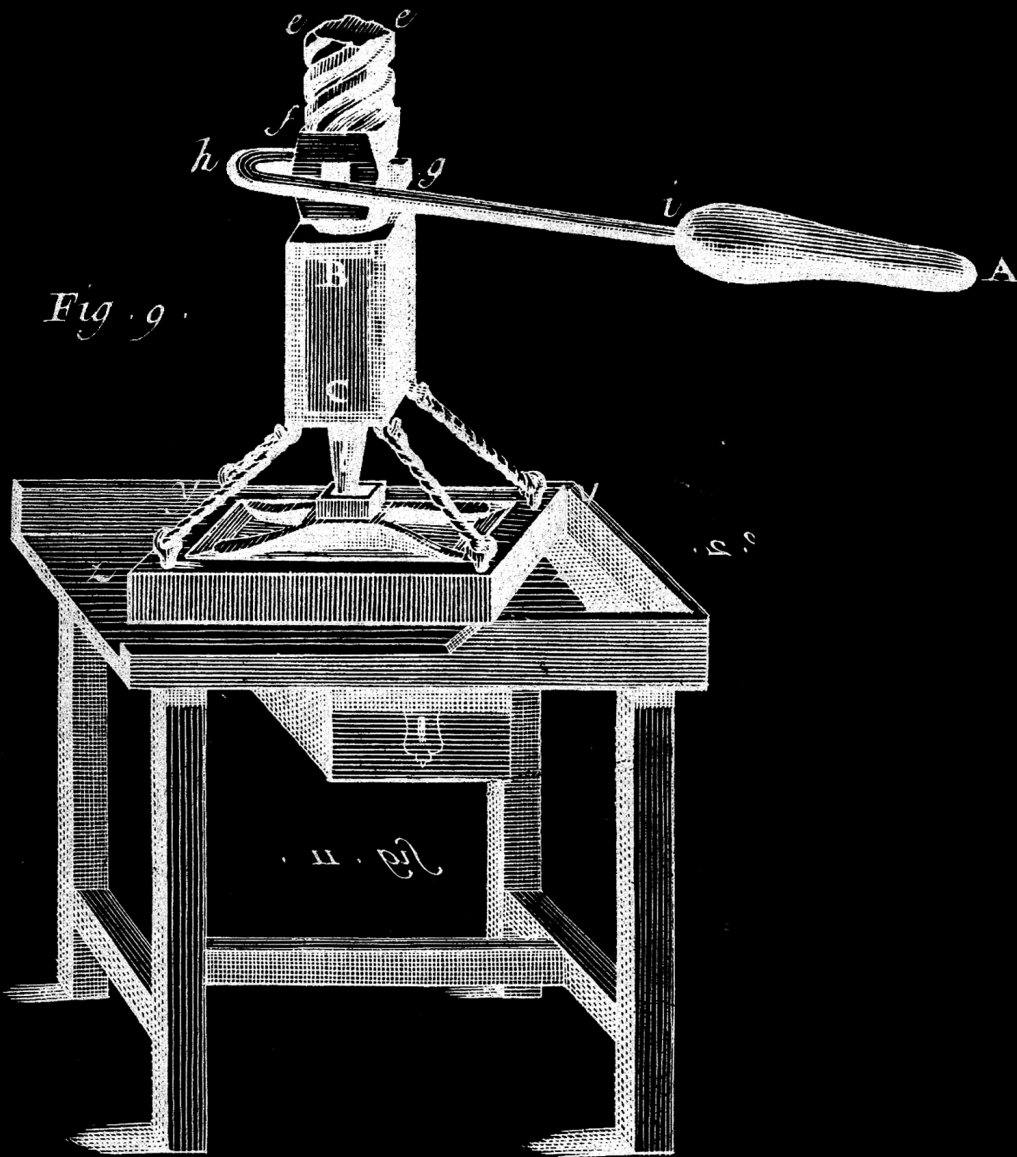


Fig. 9.

J. H. P.

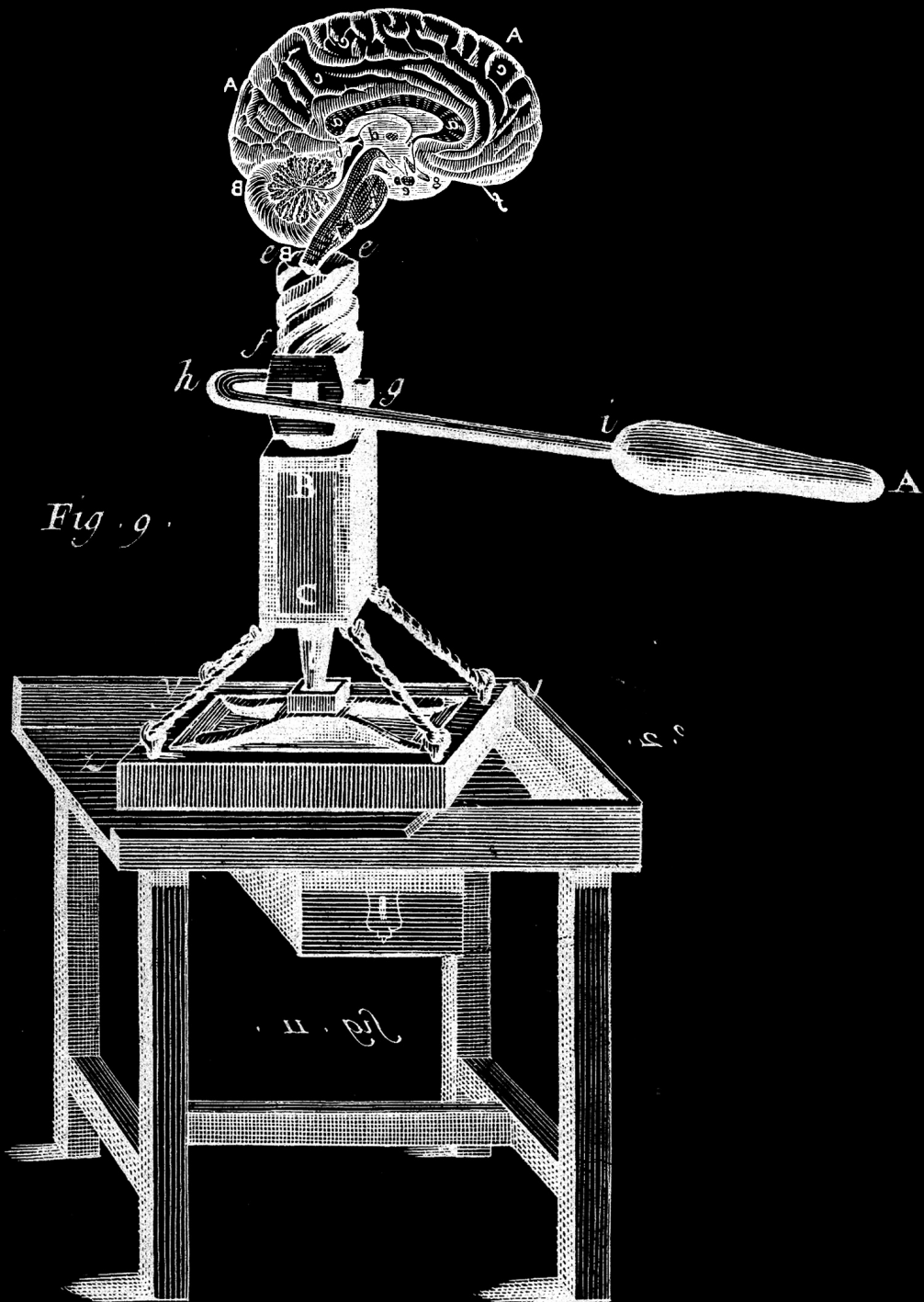
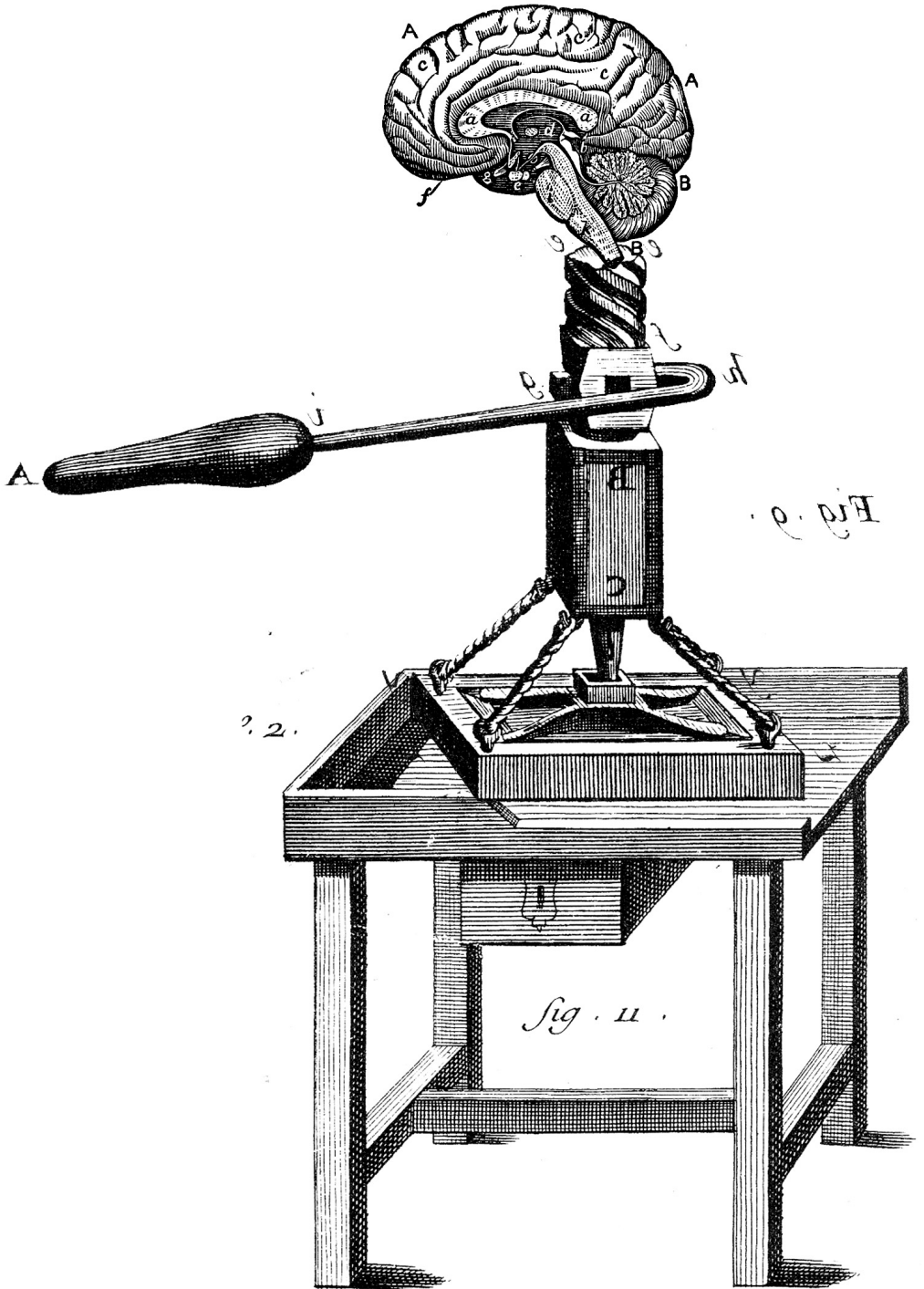


Fig. 9.

W. P. S.





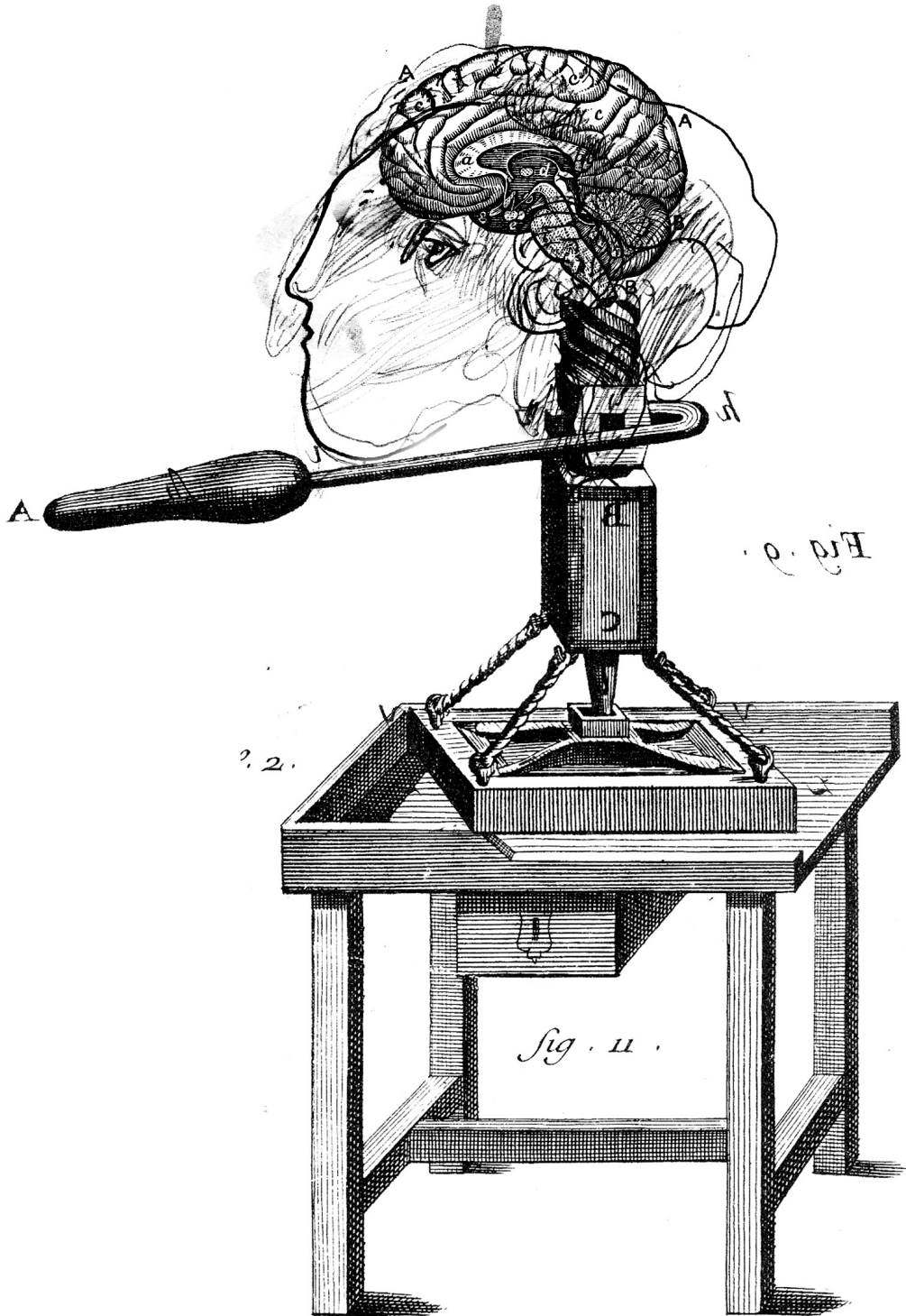
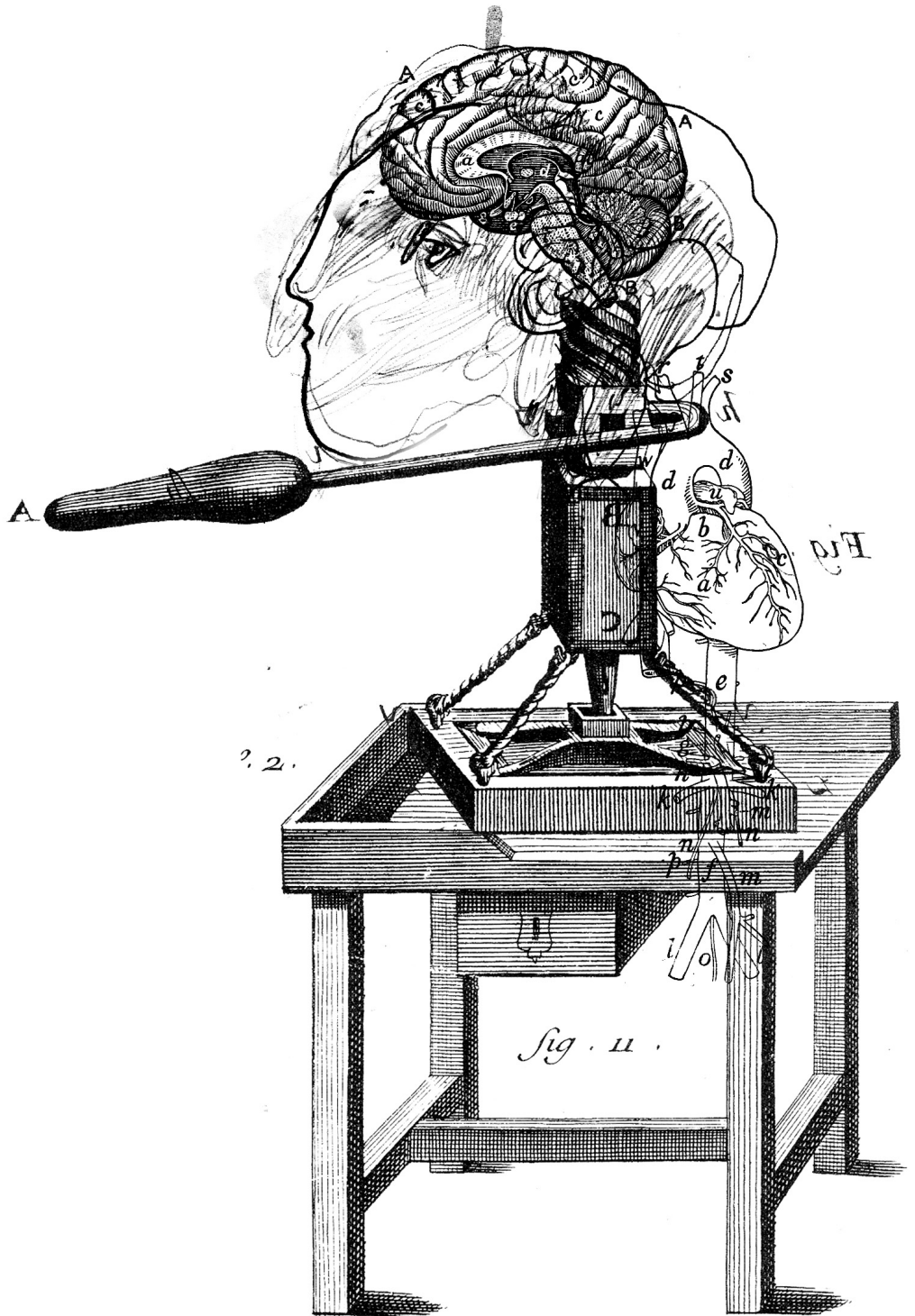
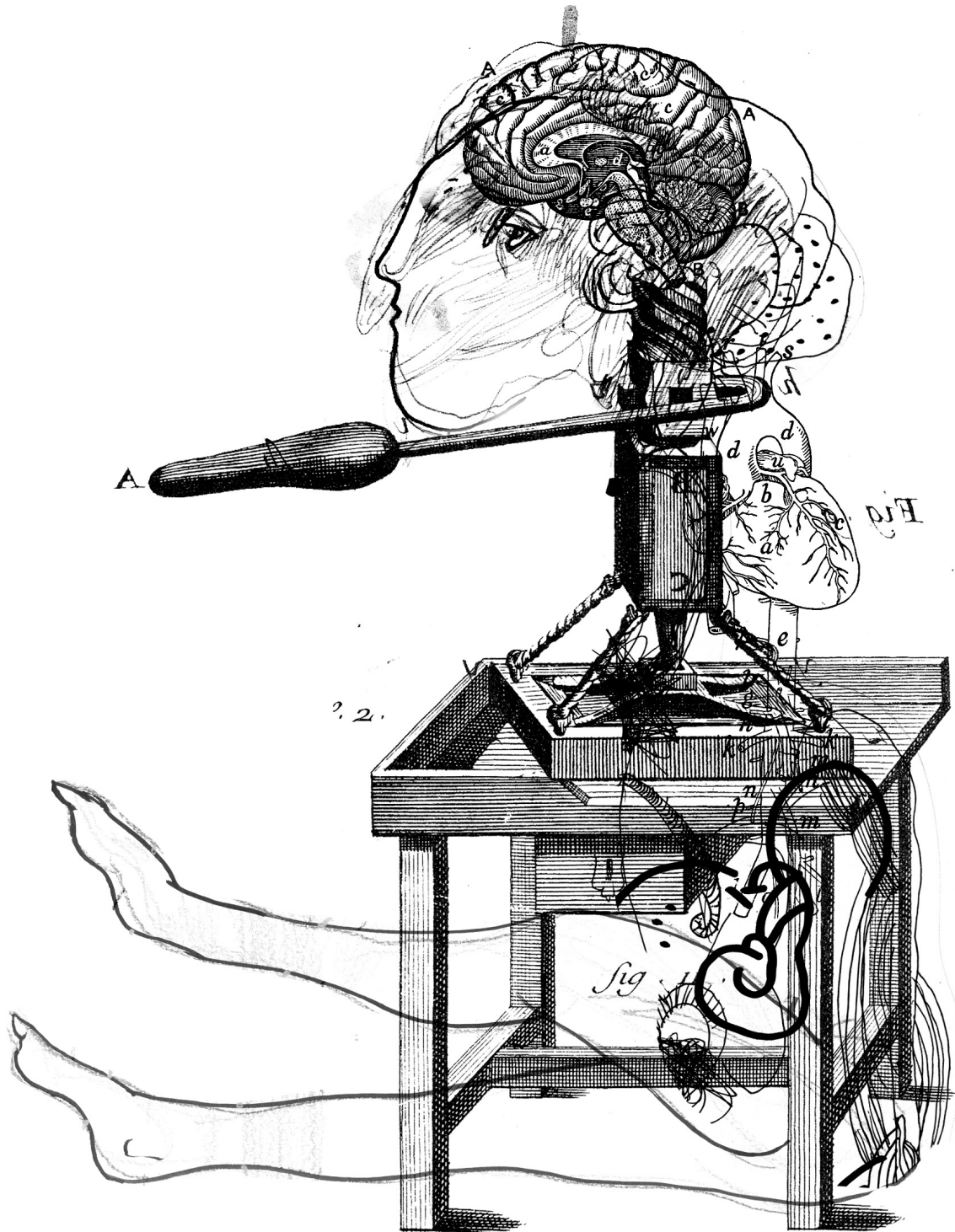


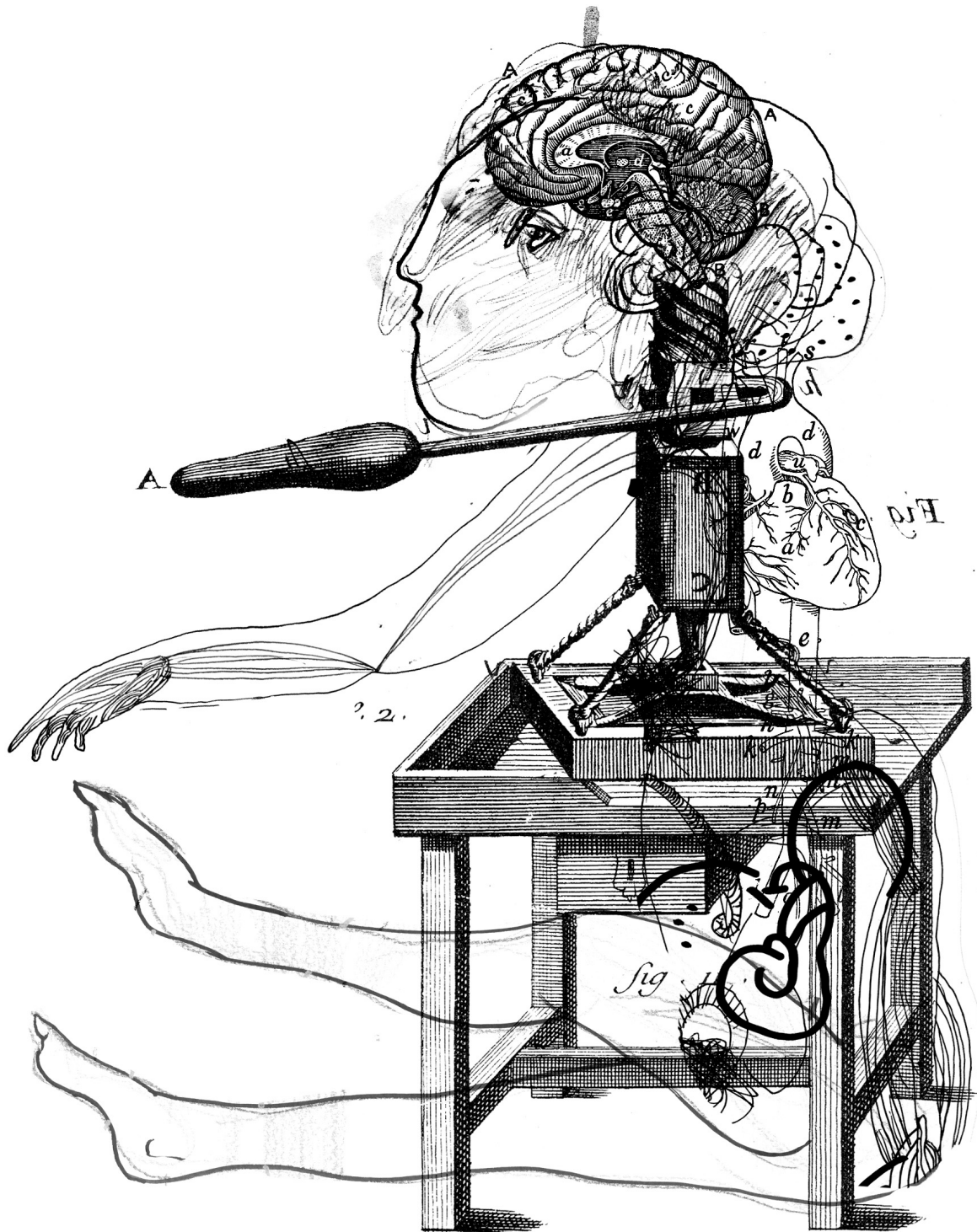
Fig. 2.

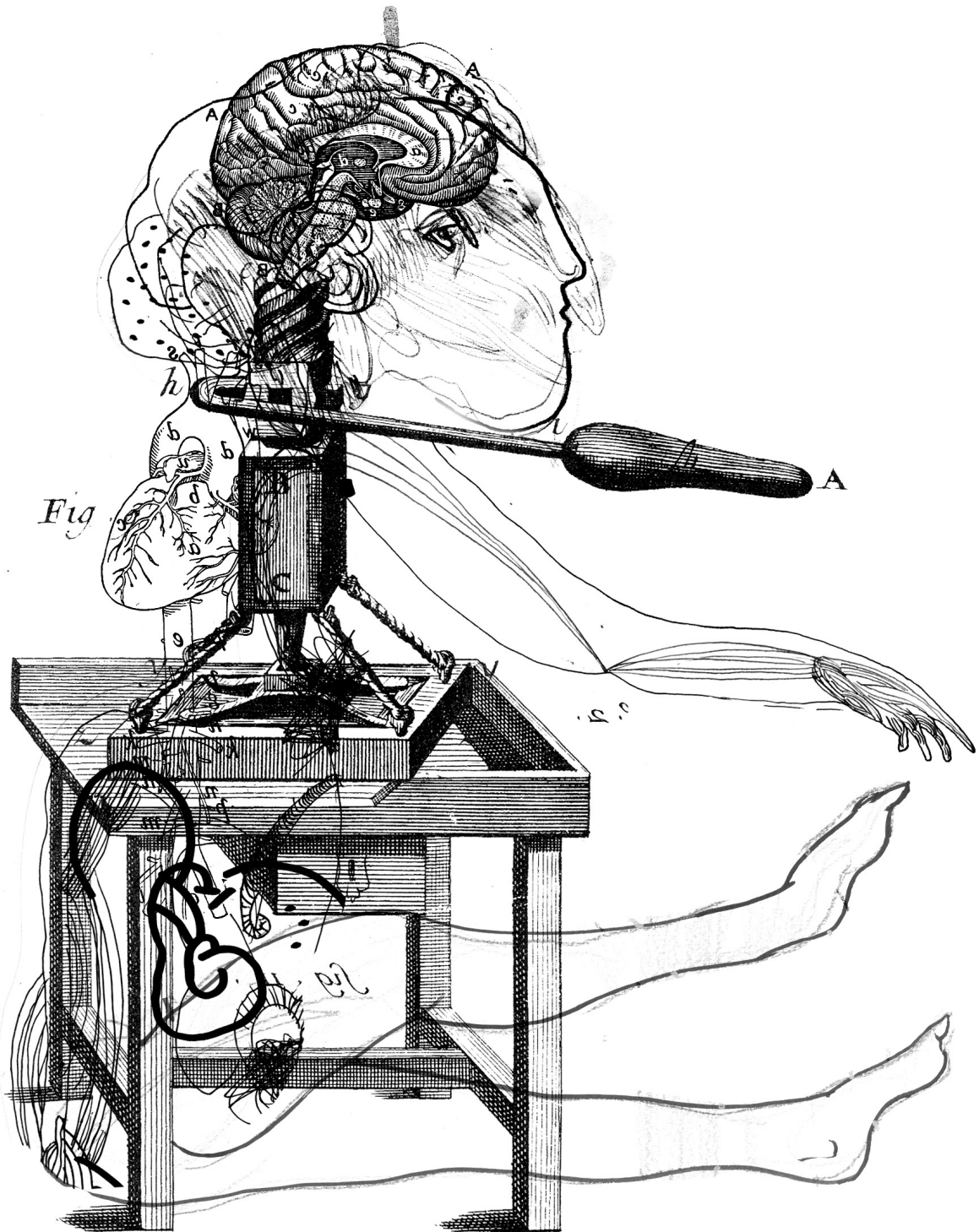
2. 2.

fig. 11.

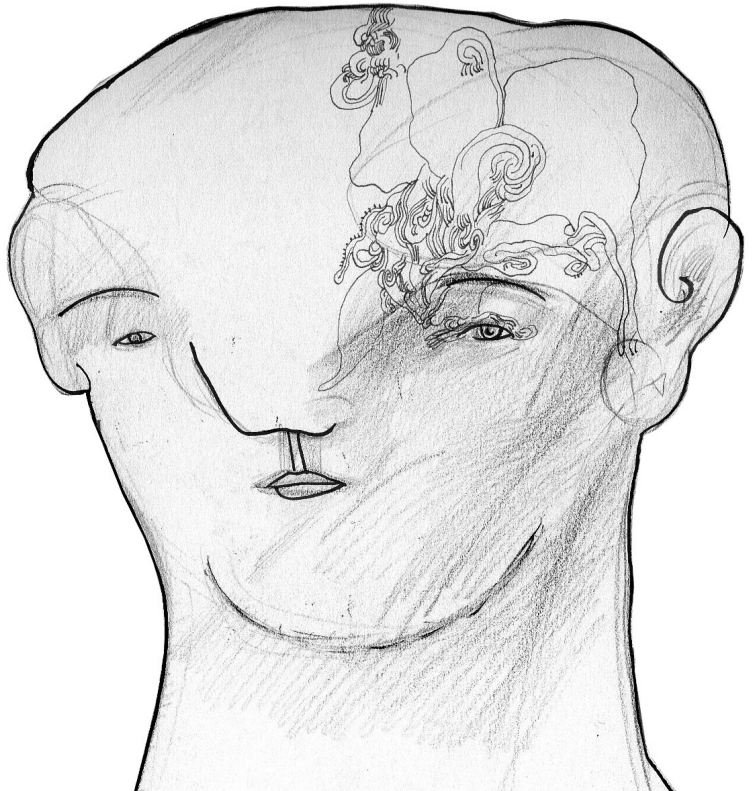


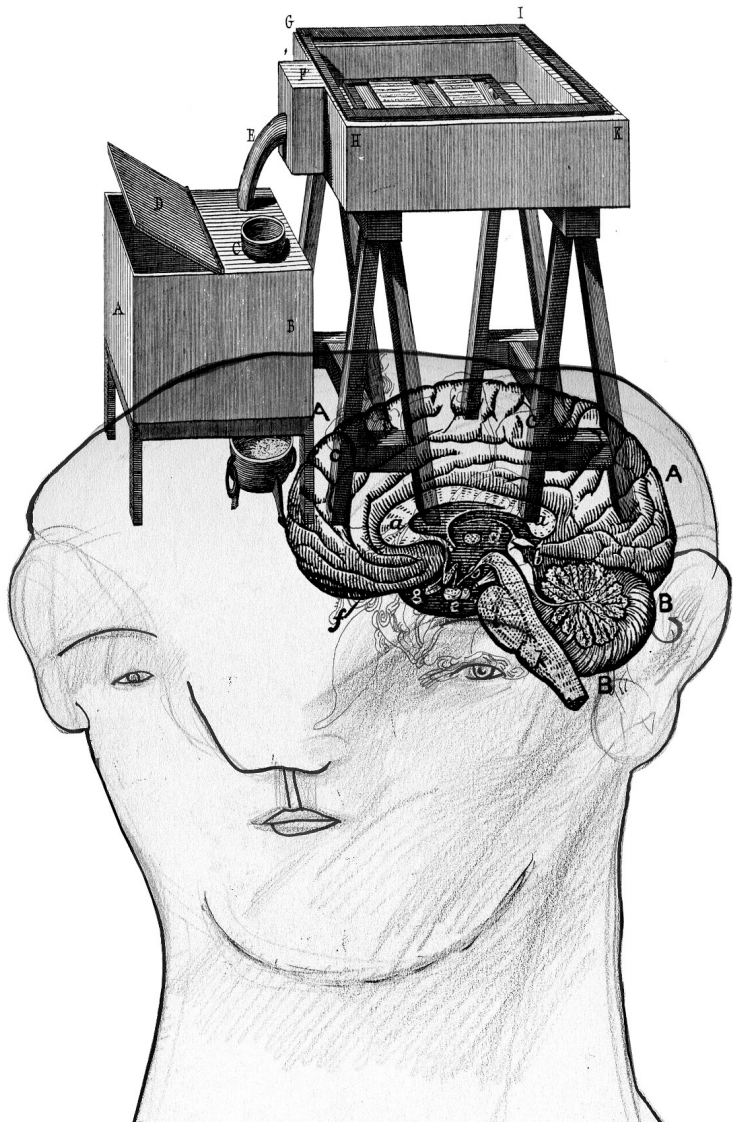


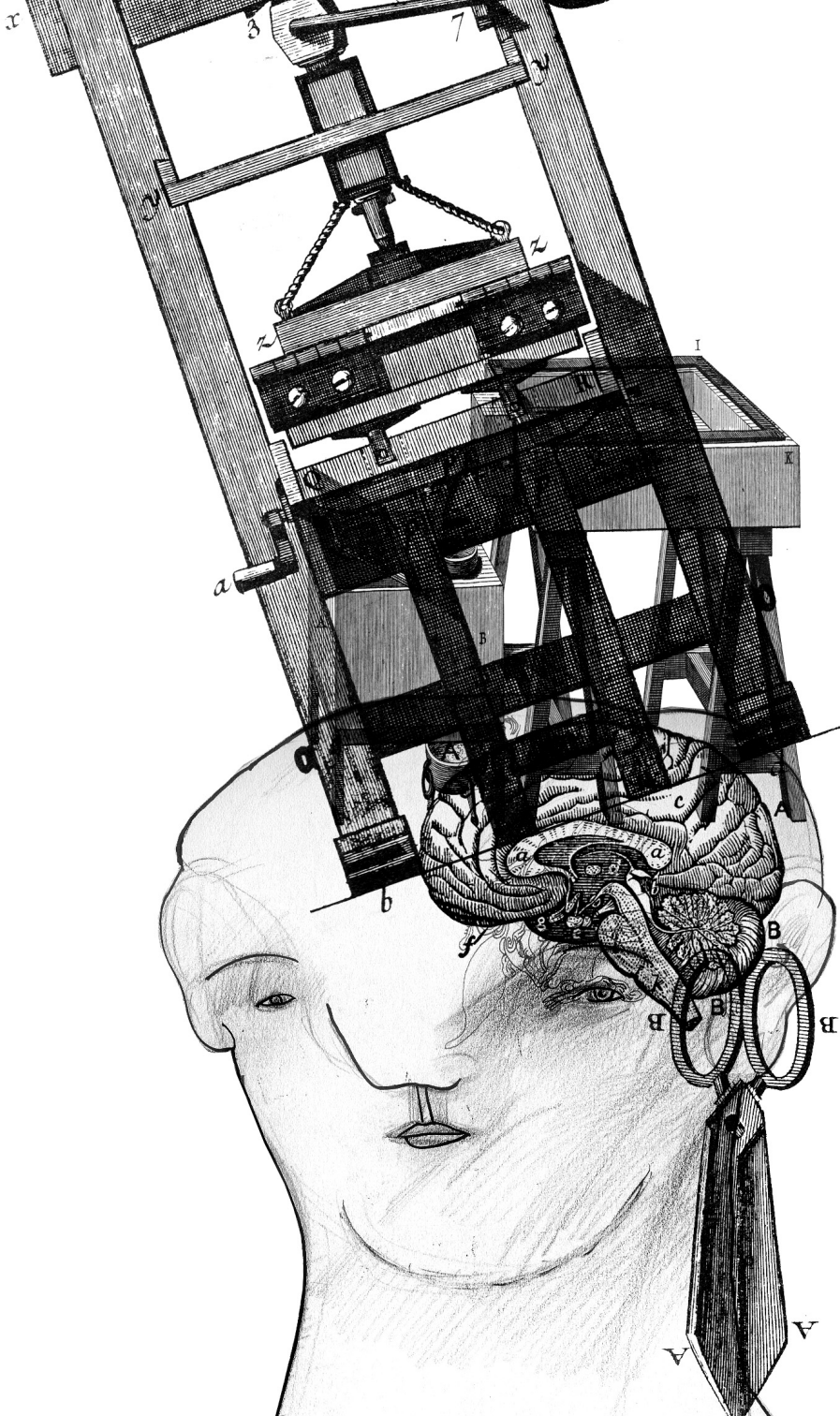




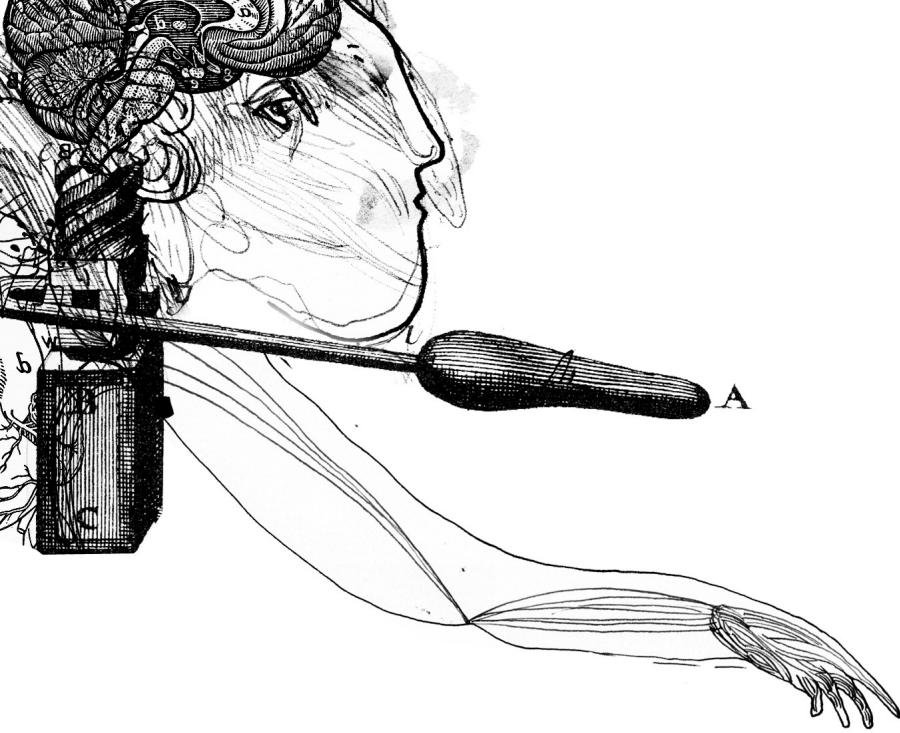
Fig

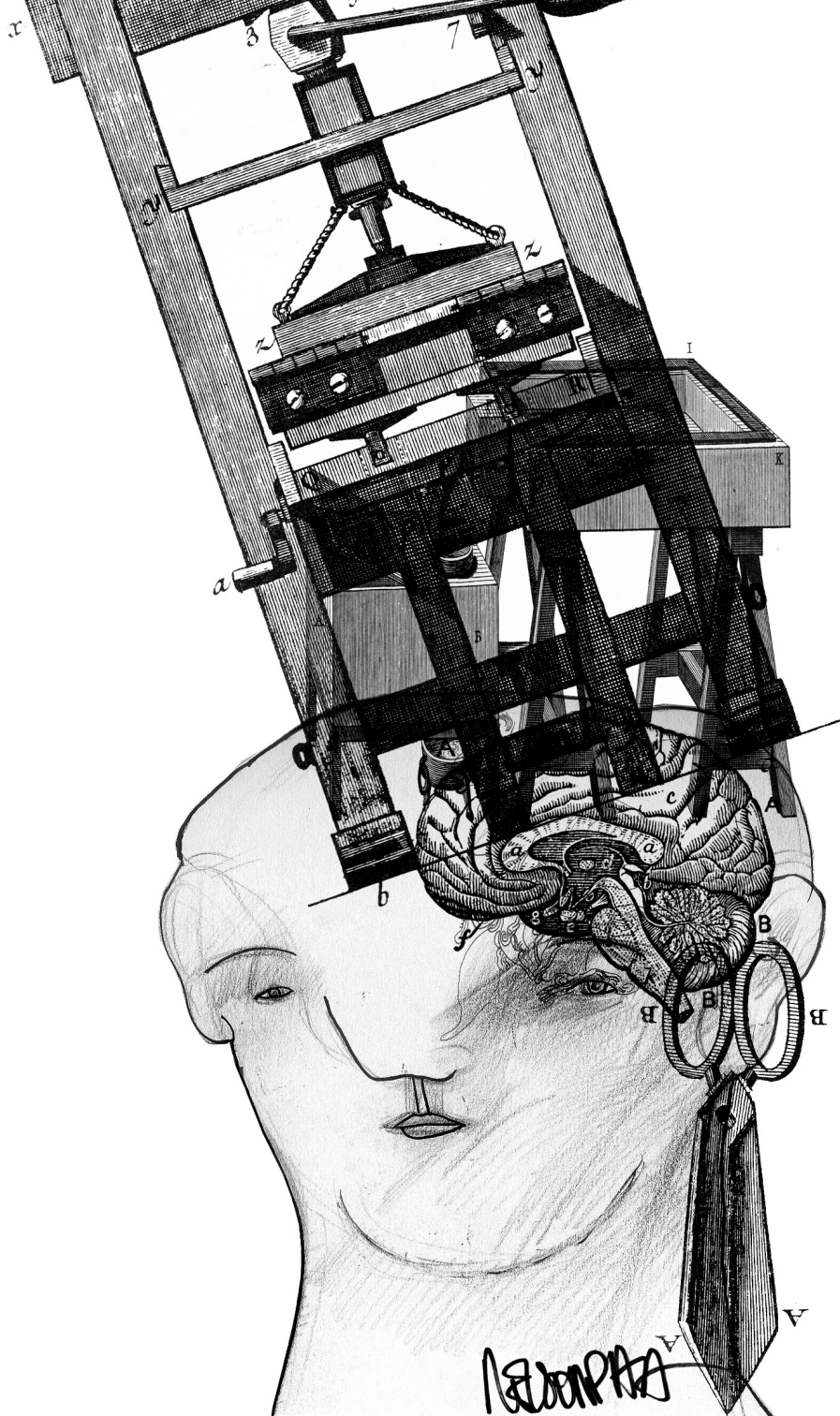












Este libro ha sido impreso en los talleres de Editora e Imprenta Maval Ltda. en Noviembre de 2010. Se tiraron 250 ejemplares en un formato de 17 x 20 cms. Interior de 122 páginas en papel Bond Ahuesado y 4 páginas en papel Couché de 130 grs. impreso a 1/1 color. Tapa en papel Couché de 275 grs.