



# Development and optimization of a modified process for producing the battery grade LiOH: Optimization of energy and water consumption



Mario Grágeda <sup>a, b, \*</sup>, Alonso González <sup>a</sup>, Wilson Alavia <sup>a</sup>, Svetlana Ushak <sup>a, b</sup>

<sup>a</sup> Department of Chemical Engineering and Mineral Processing and Center for Advanced Study of Lithium and Industrial Minerals (CELiMIN), University of Antofagasta, Campus Coloso, Av. Universidad de Antofagasta, 02800, Antofagasta, Chile

<sup>b</sup> Solar Energy Research Center (SERC-Chile), University of Chile, Av Tupper 2007, Piso 4, Santiago, Chile

## ARTICLE INFO

### Article history:

Received 31 March 2014  
Received in revised form  
7 May 2015  
Accepted 5 June 2015  
Available online 8 July 2015

### Keywords:

LiOH battery grade  
Simulation  
Water  
Energy optimization  
Efficient process  
Sustainable

## ABSTRACT

LiOH·H<sub>2</sub>O is used for preparation of alkaline batteries. The required characteristics of this compound are low levels of impurities and a specific particle size distribution. LiOH·H<sub>2</sub>O is produced from ore and brines. In northern Chile, lithium is produced from brines. This region presents particular desert climate conditions where water and energy are scarce. To help solve this problem, the conventional production process for battery grade LiOH·H<sub>2</sub>O was simulated and a modified process was developed, with an efficient consumption of energy and water, to improve the environmental sustainability of the plant, and greater process yield and product purity.

Different configurations of the equipments were studied and for the best configurations the behavior of the modified process at different scenarios were simulated.

It was found that the purity is independent of concentration used in feed to thickeners. The process yield increases in average 2.4% for modified process due to recycling operation. In modified process is obtained 28% more product mass, specific energy consumption decreases up to 4.8% and losses of Li/kg of product decreased by 83% compared to conventional process. The water consumption per kg of product in modified process is 1%–6.3%, being lower than in conventional process. The results presented can be considered as guidelines to address the optimization of the industrial process for obtaining the battery grade LiOH.

© 2015 Elsevier Ltd. All rights reserved.

## 1. Introduction

Currently it is a period of energy crisis. The cost of energy has increased dramatically in recent years and this trend is expected to continue [1] therefore, the industry which is the most affected due to its increasing production costs, needs to ensure energy supply and water efficiency. The efficient use of energy is essential to give continuity to any process. The optimization process is performed using different operational strategies, supported by predictive models. Pirouti [2] proposes the minimization of energy consumption in a DH (district heating). Several DH designs were performed with different operating strategies for flow,

temperature and pressure. The results of modeling and simulation determined for the best strategy that the overall annual energy consumption and the equivalent annual cost are reduced. Another case of energy efficiency and energy consumed is applied to a chiller plant [3]. It was developed an intelligent algorithm to solve the model aiming at minimizing the overall cost of the chilled water plant. The results obtained of model by built on plant operating data showed energy savings of 14% in implementing the proposed approach. Descoins [4] developed a model through simulator predictive models for water treatment in an industrial plant. It was evaluated the energy consumption in each unit operation and complete link between biological activity and the specific energy consumption is performed. Giacone [5] define a structured framework for the measurement of energy efficiency in industrial processes. The results of this structured approach are relevant for energy benchmarking, budgeting and targeting purposes. For this study was used the data of two industrial processes: glass melting and cast iron melting.

\* Corresponding author. Department of Chemical Engineering and Mineral Processing and Center for Advanced Study of Lithium and Industrial Minerals (CELiMIN), University of Antofagasta, Campus Coloso, Av. Universidad de Antofagasta, 02800, Antofagasta, Chile.

E-mail address: [mario.grageda@uantof.cl](mailto:mario.grageda@uantof.cl) (M. Grágeda).

The importance of water sources for human and industrial consumption is an evident issue. This topic is even more relevant considering the accessibility to the water sources and the environmental problems involved for its uptake. For these reasons the necessity to improve the efficient use of water in the processes is a task for the whole industry. Lin [6] conducted the study for the evaluation of strategies for managing water resources in high-tech industries, based on existing water use data from 70 industrial plants. It was assessed using three indices: processing water recovery rate, the plant water recovery rate, and the plant discharge rate. The results confirmed the synergistic effect of these indices which contribute to optimizing water use efficiency values.

Industrial processes and systems that use water are being subjected to increasingly stringent environmental regulations related to the discharge of effluents [7]. The importance of minimizing waste and indiscriminate use of water helps when applying for environmental permissions to increase production of a plant or requests for mining concessions. One example where the use of water and energy consumption is high, it is the production of lithium compounds. In this process there are problems with the use of water and energy, basically associated with the generation of effluents, treatment of effluent streams, oversized unitary equipment, high specific power consumption, among others. This necessitates the development of a global approach to the solutions methodologies to minimize water loss and excessive energy consumption [7,8].

On the other hand there is an energy consumption crisis in countries which energetic matrix depends on fossil fuels but they are mostly non producers. These countries are highly dependent and susceptible to changes in the global energy market. In addition the location and their climate conditions is an important factor to improve or worsen the crisis. For example in desert places the need to save water and energy is even more critical. This is the case of Chile, where most of their mining industries are located in the driest desert in the world, the Atacama Desert.

In northern Chile the main lithium source is the brines from the Atacama salt lake. This region presents particular climate conditions such as high radiation index, low rain fall therefore a high evaporation rate but water and energy are scarce. That is a problem for the production of lithium compounds. Lithium hydroxide monohydrate is used for the fabrication of the components of lithium batteries. For that purposes the required characteristics of this compound are low levels of impurities, especially sodium, calcium and chloride, and a particle size distribution between  $-140 + 18$  US mesh. This compound is produced from lithium minerals and brines.

The process to obtain the lithium hydroxide begins when the lithium brine is concentrated in the evaporation ponds with lithium content from 5.5 to 6.0%, it is equivalent to 35–40% of LiCl. This brine is then purified in one or two stages to remove the impurities, mainly residual magnesium and calcium. The purified brine, previously filtered to separate the suspended solids, is treated with sodium carbonate in hot ( $90\text{ }^{\circ}\text{C}$ – $95\text{ }^{\circ}\text{C}$ ) to precipitate the lithium by the following reaction:

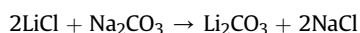

The lithium carbonate precipitated is settled and filtered hot and then washed extensively with dematerialized hot water in the filter. Subsequently, for obtaining lithium hydroxide,  $\text{Li}_2\text{CO}_3$  (technical Lithium carbonate 99%) with  $\text{Ca}(\text{OH})_2$  are reacted [9,10]. A former process base on the same fundament is presented by Hader et al. [11].

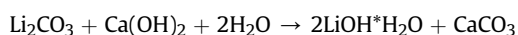

Although this process is not complex, it has several important disadvantages. For example, to obtain a high quality  $\text{LiOH}\cdot\text{H}_2\text{O}$ , a high degree of purity of the starting components is required. Moreover, taking into account the low solubility of  $\text{Ca}(\text{OH})_2$ , this process is characterized by the low yield of LiOH in solution and great loss of  $\text{Li}^+$ , all associated with the necessity of washing and settling voluminous precipitates of  $\text{CaCO}_3$  [12].

Nemkov et al. [12] Indicates that the Lithium hydroxide obtaining process from Lithium carbonate is inefficient if it is performed directly, consequently they convert the lithium carbonate to lithium sulfate, by sulfuric acid addition, after separate the lithium form the solution by electrolysis membranes [13]. This process could be used for lithium recovering from wastes containing lithium.

To evaluate the behavior, the working strategies and later optimization of the lithium hydroxide monohydrated production process, the development of accurate models and simulations able to give the streams and chemistry involved, must be considered. The information generated is used to develop alternative solutions for better processes, yield increases, decreases operational cost and specially improves the quality of the product.

The main tools for process engineering for sizing equipments and estimating the cost for steam, air, water and other consumption are the mass and energy balances; therefore during the operation of a plant, the mass balance gives information about the performance of the process. That information is useful to determine the mass flow of the streams of the process, and the energetic requirements of the process.

The bases for these balances are simple, but its application could be complicated, unless an appropriate methodology is used. Currently they are available much commercial software for performing that balances.

Qing [14] analyzed the usefulness of the software Metsim for performing energy and mass balances applied to different hydro-metallurgical processes, for dissolution and crystallization. Based on experimental data and reasonable assumptions, the calculation gave important information for potential industrial applications in scaling and equipments design. The description of the calculation methodology of Metsim and the software applications in Metallurgy is presented by Zhao et al. [15]. Werther [16] used the software Solid Sim to adjust some parameters for the model to measured data to obtain a good description for a given technical process. Due to the fact that measured data have experimental error they have to be treated statistically before using for parameters determination. In consequence in that work a methodology was developed and implemented as prototypical extension of the flowchart of the simulation tool Solid Sim.

Therefore the aim of this contribution is to simulate the conventional production process for battery grade  $\text{LiOH}\cdot\text{H}_2\text{O}$  and propose a new process, modified process, which has an efficient consumption of water and energy, to improve the environmental sustainability of the plant, and greater process yield and product purity and meets the particle size requirements. Then the results obtained can be considered as guidelines to address the optimization of the industrial process for obtaining the battery grade LiOH.

For that purpose different configuration of the equipments in the process were studied and for the best configurations the behavior of the modified process at different scenarios were simulated. The cases are:

- I. Effect of LiOH concentration in the outlet solution from the conversion reactor on the product purity and process yield. Concentration levels 8, 10 and 12% LiOH.
- II. Water feed effect on the washing in the thickening stage.

III. Relationships of the lithium loss and LiOH concentration with the heat amount required in the evaporation stage. This case is studied for three levels of water feed 0, 1000 and 2000 kg/h.

IV. Different operation conditions in the crystallizer: Pressure, temperature and heat amount feed.

To assure the reliability of the data generated from the simulation model for the modified process, and therefore the conclusions reached, first a simulation model was developed using the industrial experience and the information available from our research group and implemented in METSIM software [15,17]. This model was validated reproducing the conventional process for obtaining the battery grade LiOH reported in literature. It is worthy to mention that the originality of this work lies in the implementation of routines, controllers and user functions to represent properly the evaporation, crystallization and screening stages of the conventional obtaining process for Battery grade LiOH and validate it. After that the simulation model was used to understand the behavior of the system and evaluate many alternatives, based on the expertise of our group in process design, phase equilibria, and process for obtaining lithium compounds from brines, to optimize the product purity, and the water and energy consumption. The best result obtained is the modified process presented in this work. The results obtained from the modified process are presented as guidelines to address the optimization of the industrial process for obtaining the battery grade LiOH.

## 2. Theory

### 2.1. Equipment description

In Table 1 is presented a brief description of the equipments used in the simulation.

### 2.2. Process description

#### 2.2.1. Conventional process

Wilkomirsky [9,10] described a conventional process for obtaining lithium hydroxide by reacting lithium carbonate with calcium hydroxide given by the following reaction:

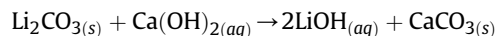

The process could be divided based on this reaction in many stages, such as dissolution, conversion, thickening, evaporation and crystallization, classification and packing. The scheme of this process is presented in Fig. 1.

First, suspensions of  $\text{Li}_2\text{CO}_3$  and  $\text{Ca}(\text{OH})_2$  are prepared by mixing  $\text{Li}_2\text{CO}_3$  and reacting CaO with water respectively. These suspensions are sent to a reactor, where they are reacted forming lithium hydroxide in solution and calcium carbonate as solid. The precipitated solid and the solution are separated by a system of settlers with washing in crosscurrent. The washing is performed to decrease the lithium loss in the discards of the process. The solution obtained from the settlers is 10% in lithium hydroxide and is sent to a filtration system to separate the remaining solids before sending it to the evaporation stage. The evaporation is done in a triple effect equipment to concentrate the solution until saturation in LiOH and after it crystallizes  $\text{LiOH} \cdot \text{H}_2\text{O}$ . The suspension obtained is sent to a solid–liquid separation equipment of high efficiency, a part of the filtered is discarded to avoid accumulation of impurities and the rest is recirculated to the evaporation stage. The filter cake is sent to a dryer that works at 80–100 °C. The dried solid is classified and the product with the proper granulometry is packed. The yield is the

process is greater than 90% and the purity of the product is greater than 99%.

#### 2.2.2. Modified process

A modified process for obtaining  $\text{LiOH} \cdot \text{H}_2\text{O}$  is presented here, it was developed based on the conventional process but with modifications. The proposal modifications are shown in Fig. 2.

The new process presents the following changes respect to the conventional one: higher efficiency equipment for the solid–liquid separation of the suspension obtained at the underflow at the first settler, instead of the press filter; screening equipment at the outlet of the crystallizer that defines the particle size distribution for the final product. In addition recirculation is considered to improve the yield of the process.

### 2.3. Process simulation

The simulation of the modified process for obtaining  $\text{LiOH} \cdot \text{H}_2\text{O}$  was performed and it is described in this section. For the simulation the process was divided in the following steps: Dissolution and conversion, thickening, evaporation and crystallization, drying, classification and packing.

#### 2.3.1. Dissolution and conversion

The process is fed with CaO (98.4%) and  $\text{Li}_2\text{CO}_3$  of technical grade. The chemical composition of  $\text{Li}_2\text{CO}_3$  is shown in Table 2. The CaO has 2.6% of  $\text{SiO}_2$  as impurity. The  $\text{Li}_2\text{CO}_3$  is mixed with water in a tank to prepare a suspension (stream 6), and CaO is reacted with water to prepare a suspension of  $\text{Ca}(\text{OH})_2$  (stream 5).

For every suspension prepared the water addition is determined in such a way to reach a 30% in solid concentration. The stream 5 and 6 has a stoichiometric relationship and this is control by the controller show in Fig. 3. The value function used for this controller is the ratio between the Feed  $\text{Ca}(\text{OH})_2$  in stream 5 and the Feed  $\text{Li}_2\text{CO}_3$  in stream 6.

In the reactor 1, the main chemical reaction of the process, the formation of LiOH, takes place by the following reaction:

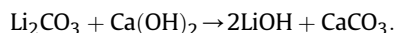

There all the lithium is transformed to LiOH. This reaction is endothermic, therefore needs heat to happen. As product a suspension composed by LiOH solution and  $\text{CaCO}_3$  precipitated is obtained, in stream 7. The suspension is between 60 and 70 °C. In addition the stream 44 is fed to the reactor; this stream comes from the dissolution tank of fines and coarse particles of the product.

#### 2.3.2. Thickening











As shown in Fig. 4 the suspension coming from the dissolution and conversion stage is fed to a system of thickeners. The configuration of the system is made to reach a solid concentration in underflows of 40% and 2% in overflow respectively. The underflow stream is fed to next thickener, previously mixed with the overflow of the next equipment to decrease the solid concentration.

As shown in Fig. 4, the underflow from the thickener 2 (stream 9) is mixed to the overflow from the thickener 3 (stream 12), obtaining the fed for thickener 2.

To the thickener 4 is fed fresh water (stream 16) for washing. The fed is regulated by control 16 to assure that a LiOH concentration in solution between 6 and 8% is reached at the stream 8.

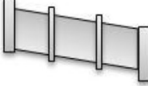
To separate the  $\text{CaCO}_3$ , a solid–liquid separation equipment, Separation 1 S/L, of 86% of efficiency, is used. The solid is discarded in stream 17 and the remaining liquid, stream 18, is recirculated to the thickener 3.

**Table 1**  
Description of the equipments used in the simulation.

| Symbol  | Description  |
|---|--|
|    | Mixer tank, this is a tank with mechanical stirring. It can manage solid disintegrating, heat transfer and chemical reactions.   |
|    | Thickener/Clarifier, this is a solid–liquid separation equipment. The outlet streams are determined as function of the solid percentage at the inlet and outlet streams.   |
|    | Press filter, this is a solid–liquid separation equipment. The input parameters are the solid humidity in the filter cake and the solid percentage in the filtrate solution respectively   |
|    | Centrifuge, this is a solid–liquid separation equipment of high efficiency. The input parameters are the solid humidity in the filter cake and the solid percentage in the filtrate solution respectively. Its efficiency is greater than for the Press filter.                                  |
|    | Evaporator, this is a liquid–vapor flash separator. Its outputs are liquid and vapor streams. The temperature and pressure for this separation is calculated as function of the feed and heat inputs.  |
|   | Crystallizer, this equipment concentrates a solution, through evaporation, until supersaturates it and subsequently crystallizer it. The main parameters for controlling it, are the pressure and heat (addition and lost). The crystallization process is represented using chemical reactions. |
|  | Bottom crystallizer, this equipment is coupled to the crystallizer, its function is classify the solid according to its granulometry in fine and coarse. The fines are recirculated to the crystallizer.   |
|  | Direct Rotary dryer, this equipment dries the particles. The inputs are the product humidity, heating media temperature (gas).   |
|  | Screener, this equipment classifies the solids in different sizes according their granulometry. The outlet streams are fines, medium (product), coarse and oversize.   |
|  | Separator liquid stream, this equipment separates the input stream in many streams. In the simulation is used for separate liquid streams.   |
|  | Separator liquid stream, this equipment separates the input stream in many streams. In the simulation is used to distribute the steam to the evaporators streams.  |

To separate the remaining solid in stream 8, a solid–liquid equipment of high efficiency, 99%, is used. The resultant solution, stream 20, is sent to the evaporation and crystallization stage.

### 2.3.3. Evaporation and crystallization

The clarified solution coming from the thickening stage (stream 20) is fed to the evaporator 1. Steam (stream 23) and heat are entered to this equipment to increase the temperature of the solution, therefore the vapor pressure, to evaporate the water contained. This equipment works at atmospheric pressure. To determine the amount of heat necessary to concentrate the outlet solution (stream 21) until a required value for Evaporator 2, a controller is used as can be seen in Fig. 5. The concentration of LiOH in the solution of the outlet stream was used as value function for the controller. It was calculated as follow: Weight fraction of

lithium in the liquid inorganic phase of the stream,  $S \times \text{LiOH molar weight/Li molar mass} \times 100$ . The same value function is used for the evaporator 2 and the crystallizer.

To the Evaporator 2 the stream 21 is fed, and using a controller is determined the pressure necessary to concentrate the solution, without feeding more heat to it. For this purpose the absolute pressure inside the equipment was controlled as function of the concentration of LiOH in the solution of the outlet stream, to get a properly pressure to allow the water evaporation at the working temperature, using a feedback control. In addition, the steam from the previous evaporator is distributed in a way that all the heat contained is used and the rest is sent to the next evaporator and a part is recirculated. A more concentrated solution is obtained in stream 22 and it is fed to the crystallizer.

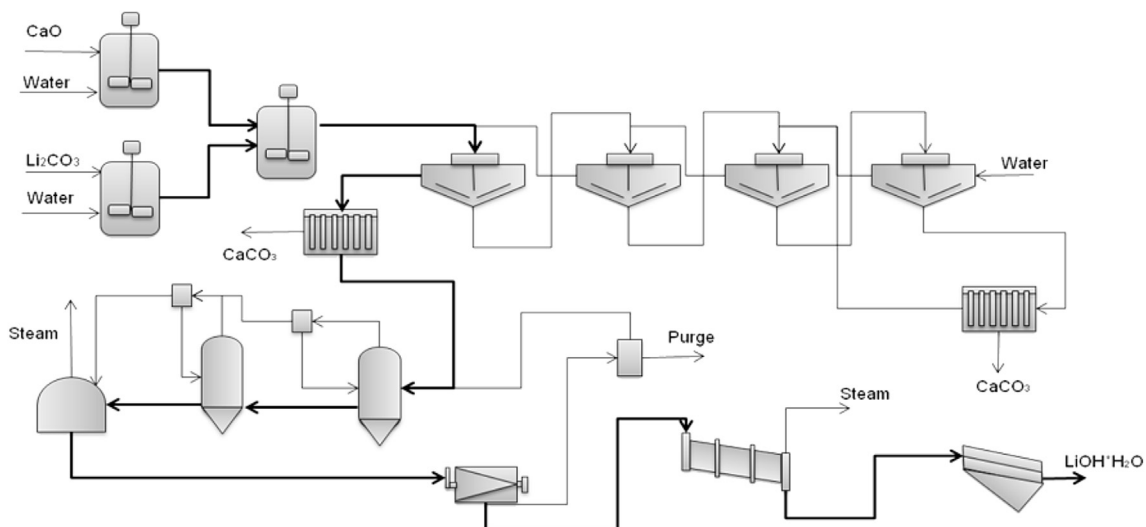

Fig. 1. Scheme of the process for obtaining LiOH·H<sub>2</sub>O from Li<sub>2</sub>CO<sub>3</sub> [9].

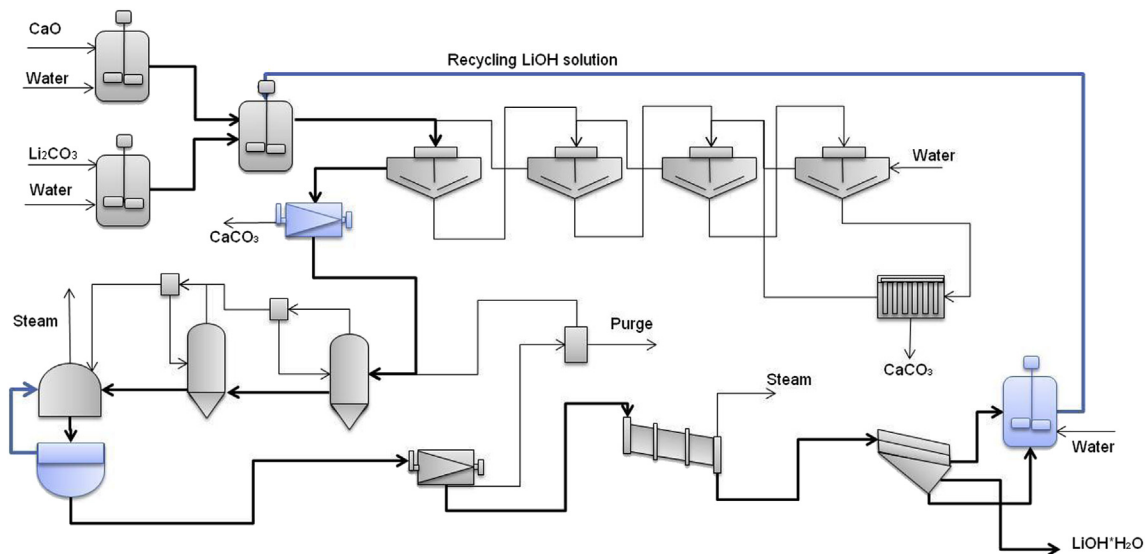

Fig. 2. Scheme of the modified process for obtaining LiOH·H<sub>2</sub>O from Li<sub>2</sub>CO<sub>3</sub>. (Changes are shown in blue color). (For interpretation of the references to color in this figure legend, the reader is referred to the web version of this article.)

The crystallizer works at vacuum, the pressure is determined by a controller to assure that the concentration and later super-saturation of the solution, necessary to produce LiOH·H<sub>2</sub>O is reached.

**Table 2**  
Chemical Composition of Li<sub>2</sub>CO<sub>3</sub> fed [8] to the modified process for obtaining LiOH·H<sub>2</sub>O.

| Compound                        | Wt. frac. |
|---------------------------------|-----------|
| Li <sub>2</sub> CO <sub>3</sub> | 0.9903689 |
| Fe <sub>2</sub> CO <sub>3</sub> | 0.0000299 |
| MgCl <sub>2</sub>               | 0.0000335 |
| NaCl                            | 0.0000411 |
| K <sub>2</sub> SO <sub>4</sub>  | 0.0063333 |
| Na <sub>2</sub> O               | 0.0008978 |
| K <sub>2</sub> O                | 0.0008978 |
| CaO                             | 0.0003990 |
| Moisture                        | 0.0010988 |

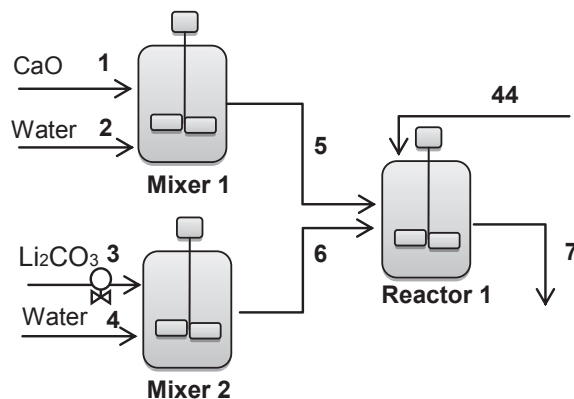

Fig. 3. Scheme of the dissolution and conversion step of the modified process for obtaining LiOH·H<sub>2</sub>O from Li<sub>2</sub>CO<sub>3</sub>.



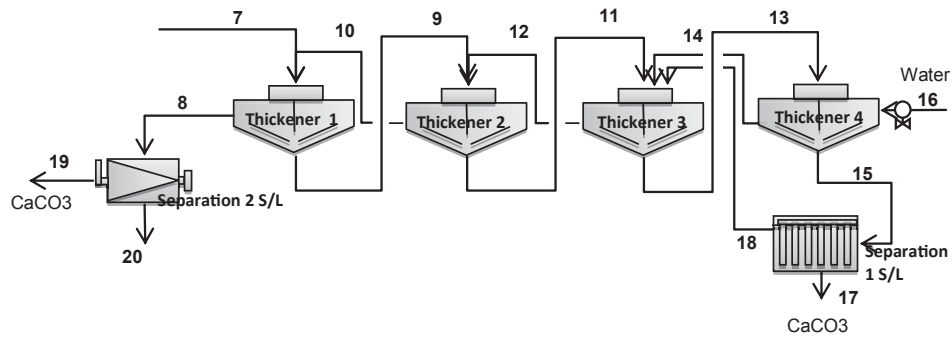

Fig. 4. Scheme of the thickening stage of the modified process for obtaining  $\text{LiOH} \cdot \text{H}_2\text{O}$  from  $\text{Li}_2\text{CO}_3$ .

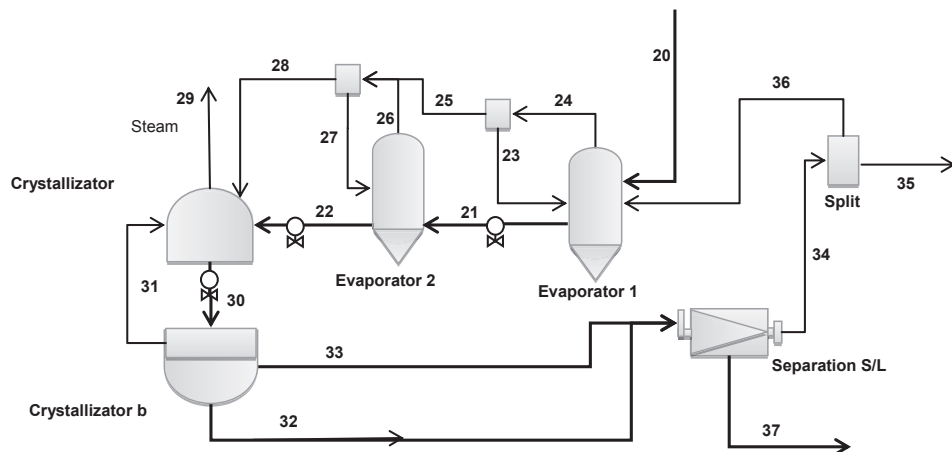
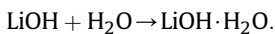

Fig. 5. Scheme of the evaporation and crystallization stage of the modified process for obtaining  $\text{LiOH} \cdot \text{H}_2\text{O}$  from  $\text{Li}_2\text{CO}_3$ .

The logic used for the feedback controllers of the evaporator 2 and crystallizer is: The value function increases when the absolute pressure decreases, due to the vapor pressure of the solution is reduced and the water evaporation is increased at the working temperature.

The crystallization process can be represented by the reaction:



A controller in the stream 30 is used to determine the conversion of this reaction. It is a function of the solubility of  $\text{LiOH}$  in water at the working temperature of the crystallizer.

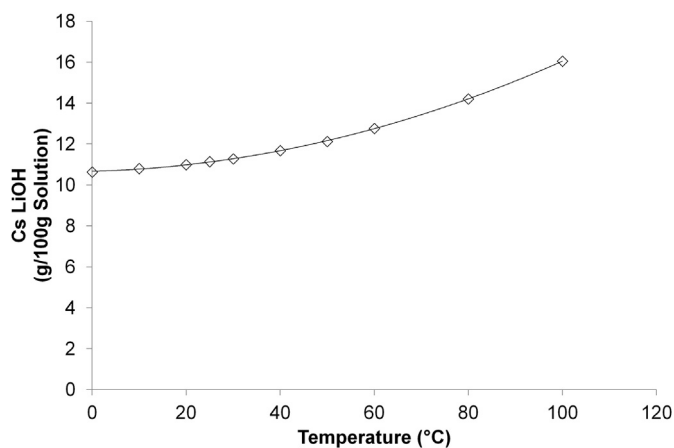

Fig. 6. Solubility of  $\text{LiOH}$  in water as function of temperature (Elaborated base on data from Ref. [18]).

In Fig. 6 is presented the solubility of  $\text{LiOH}$ ,  $C_{\text{LiOH}}$ , at different temperatures. It can be observed that this compound is more soluble at higher temperatures.

The particle size distribution, PSD, in the crystallizer was generated by a vector in the size range: 0.0005 mm–0.100 mm. To simulate the evolution of the PSD, it was supposed only crystal growth therefore the initial vector was multiplied by the mass flow rate of the  $\text{LiOH} \cdot \text{H}_2\text{O}$  produced: The value function used is following:

$$\text{Value function} = \text{Mass flow rate of } \text{LiOH} \cdot \text{H}_2\text{O} \\ \times [0 \quad 0.005 \quad 0.262 \quad 0.504 \quad 0.128 \quad 0.100]$$

This function is important due to it permits the crystals classification at the outlet of the crystallizer, in coarse and fines, to recycle the fines to the crystallizer and optimize the crystallization stage. In addition the final classification product would not be possible without the PSD generated.

The bottom of the crystallizer is a classifier where the solid is separated by size and discharge together with saturated solution and a stream of solution without solid (stream 31) is obtained too. This solution is recirculated to the crystallizer. The streams 32 and 33 are more concentrated in  $\text{LiOH} \cdot \text{H}_2\text{O}$ . They are sent to the solid–liquid separator equipment of 99% of efficiency. The stream 37 is the filter cake obtained in that equipment, this is  $\text{LiOH} \cdot \text{H}_2\text{O}$ . The filter, stream 34, is saturated solution in  $\text{LiOH}$ . A fraction of this solution is discarded, stream 35, and the rest, and stream 36, recirculated to the evaporators.

#### 2.3.4. Drying, classification and packing

The stream 37 from the previous stage is sent to a rotatory dryer. It has a humidity of 4%. This stream is dried using a mix of air and

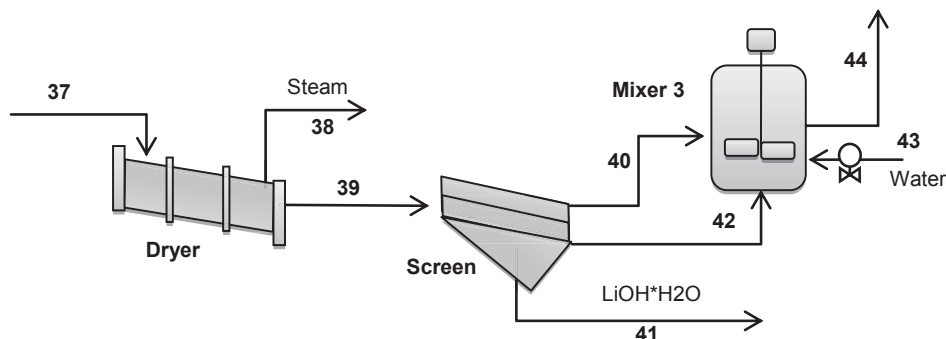

Fig. 7. Scheme of the drying, classification and packing stage of the modified process for obtaining  $\text{LiOH}\cdot\text{H}_2\text{O}$  from  $\text{Li}_2\text{CO}_3$ .

combustion gasses. The final humidity of the cake is 0.05% approximately, stream 39. This equipment Works between 70 °C and 75 °C. The stream 38 contains the gasses generated in this operation. A scheme of this stage is shown in Fig. 7.

The cake is sent to a screener where the solid is classified in different fractions according to the size. The product size is obtained, coarse and fines. The coarse and fines are dissolved in the mixer 3 using water. The water fed, stream 43, is determined using a controller. The resulting solution, stream 44, is concentrated 10% in LiOH. This is recirculated to the reactor 1. The product, stream 41, is sent to the packing stage and packed in bags according to weight presentation.

2.4. Cases studied

2.4.1. Effect of LiOH concentration in the outlet solution from the conversion reactor on the product purity and process yield. Concentration levels 8, 10 and 12% LiOH

To study the effect of the solution concentration of LiOH in the outlet solution from the conversion reactor on the purity and yield of the process, a controller was used in the dissolution and conversion stage. This controller allowed to set the amount of water fed to the reactor 1 (Fig. 3) to obtain a target concentration value in stream 7, the value function for the control is calculated by mass balance and the amount of water is adjusted to match the target concentration, 8, 10 and 12% LiOH in the stream 7. For each iteration of the simulation the purity quotient of the mass of  $\text{LiOH}\cdot\text{H}_2\text{O}$

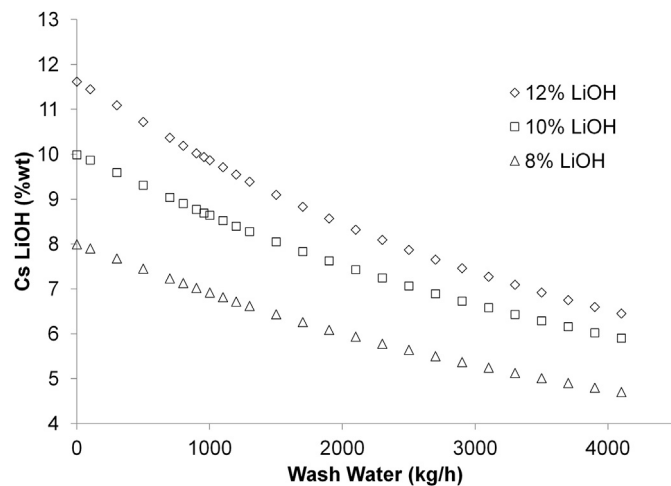

Fig. 8. Effect of the amount of fresh water for washing on the LiOH concentration in the outlet solution of the thickener system at different LiOH concentrations in the inlet solution.

obtained and the total product mass was calculated, and the process yield. It was calculated from the Li recovery in product as compared to the mass supply lithium.

2.4.2. Water feed effect on the washing in the thickening stage

After simulating the thickeners countercurrent stage, it was studied the effect of water on the solution concentration and

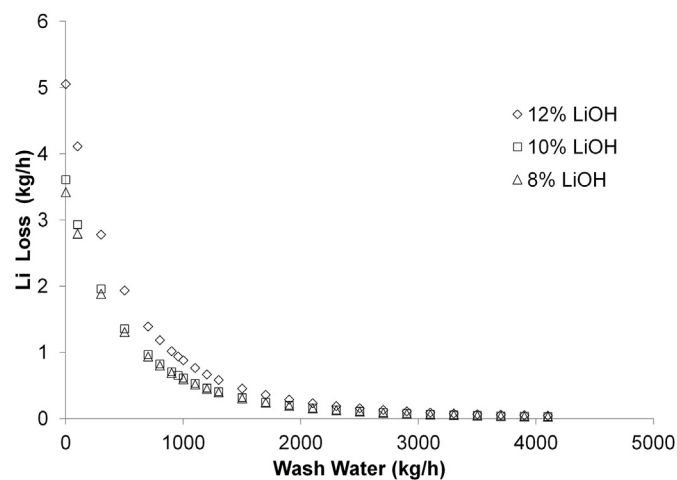

Fig. 9. Effect of the amount of fresh water for washing on the Li loss in the discarded solution of the thickener system at different LiOH concentrations in the inlet solution.

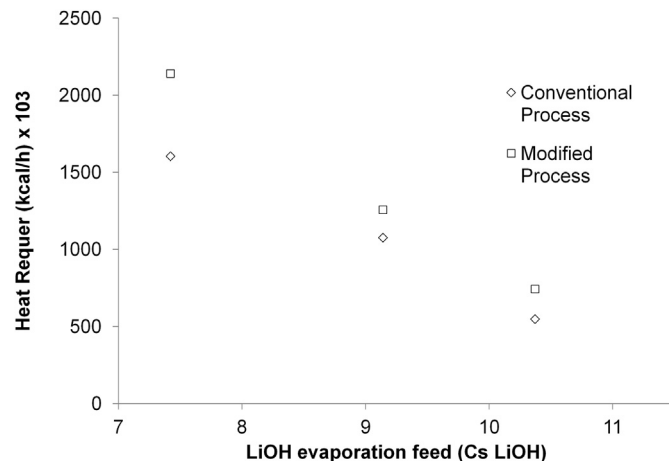

Fig. 10. Required heat for evaporation as a function of the LiOH concentration in the solution feed to the evaporation stage.

**Table 3**  
Operation conditions in the thickeners system.

| Process step | Under    |                 | Over     |                 | Over/under |
|--------------|----------|-----------------|----------|-----------------|------------|
|              | % Solids | % LiOH solution | % Solids | % LiOH solution |            |
| Thickener 1  | 40       | 10              | 2        | 9.94            | 2.67       |
| Thickener 2  | 40       | 6.1             | 2        | 6.06            | 0.99       |
| Thickener 3  | 40       | 3.6             | 2        | 3.6             | 0.87       |
| Thickener 4  | 40       | 2.2             | 2        | 2.2             | 0.41       |

lithium loss. For each concentration of feed to this stage (8, 10, 12% LiOH in stream 7), the simulation was run 26 times with different values of feed stream in the wash water stream 16. The results simulation obtained are shown in Figs. 8 and 9.

**2.4.3. Relationships of the lithium loss and LiOH concentration with the heat amount required in the evaporation stage. This case is studied for three levels of water feed 0, 1000 and 2000 kg/h**

During the development of the case study 2.4.2., it was observed that there is a relationship between the amount of loss lithium and the concentration of LiOH. For each, the conventional and modified process, the simulation was run 3 times with different values of LiOH concentration in stream 20 (Fig. 5). Thus the amount of heat required for the evaporation step was determined and recorded. The results of these simulations are presented in Fig. 10. In this way it was possible to analyze the relationship between the loss of lithium and the heat required in the evaporation step, Table 5.

**2.4.4. Different operation conditions in the crystallizer: pressure, temperature and heat amount feed**

The crystallizer was simulated independently. Pressure values were simulated; the simulation results were the operation temperatures. From the data obtained, temperature, the solubility of LiOH was determined from Fig. 6, in this way the value of the conversion factor to LiOH aqueous LiOH·H<sub>2</sub>O was obtained. This was done for three different amounts of heat added to the crystallizer (0, 500 and 1000 Mcal/h). The results of the simulations are presented in Figs. 11–13.

### 3. Results

The main results of the simulation using Metsim for each stage are shown below.

**Table 4**  
Operation conditions in the evaporator and crystallizer.

| Parameter      | Evaporator I | Evaporator II | Crystallizer |
|----------------|--------------|---------------|--------------|
| Temperature °C | 106.03       | 88.77         | 70.00        |
| Pressure kPa   | 101.33       | 53.70         | 22.97        |
| % LiOH inlet   | 9.99         | 11.82         | 12.20        |
| %LiOH outlet   | 11.82        | 12.20         | 13.59        |

**Table 5**  
Process parameters for the scenarios studied.

|  | Scenario 1 | Scenario 2 | Scenario 3 |
|--|------------|------------|------------|
| Flow rate fresh water for washing kg/h | 0          | 1000       | 2000       |
| %LiOH feed to evaporators              | 11.6       | 9.9        | 8.4        |
| Lose lithium kg/h                      | 5          | 0.9        | 0.25       |
| Heat required kcal/h                   | 0          | 700,000    | 1,400,000  |

#### 3.1. Dissolution and conversion

In the mixer 1 and 2, suspensions of 30% in solids of Ca(OH)<sub>2</sub> and Li<sub>2</sub>CO<sub>3</sub> were obtained. The reaction conversion from Li<sub>2</sub>CO<sub>3</sub> to LiOH was complete. This is due to the fact that the reagents were fed stoichiometrically. The resultant suspension was composed by 11–16% in solids and a solution of 8–12% LiOH.

#### 3.2. Thickening

The crosscurrent configuration of the thickening system reduced the amount of lithium hydroxide loss in the discarded solids, as well this contributes to dilute the suspensions feed to the thickeners. Therefore the washing water feed to the last thickener is

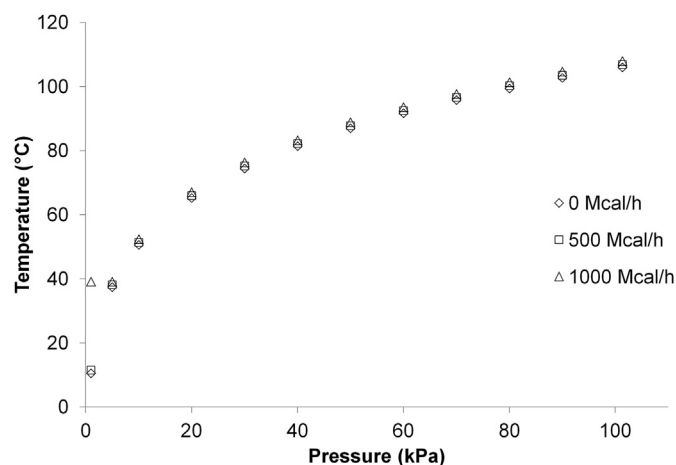

**Fig. 11.** Dependence of the temperature with the pressure in the crystallizer for different heat consumptions.

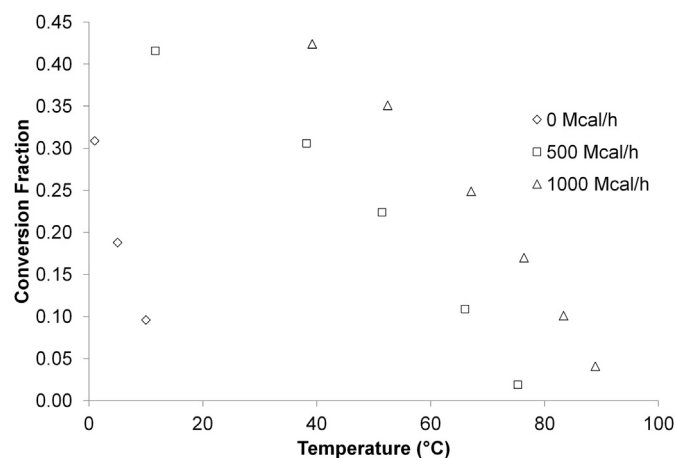

**Fig. 12.** Effect of the temperature on the conversion fraction in the crystallizer at different amounts of heat added.



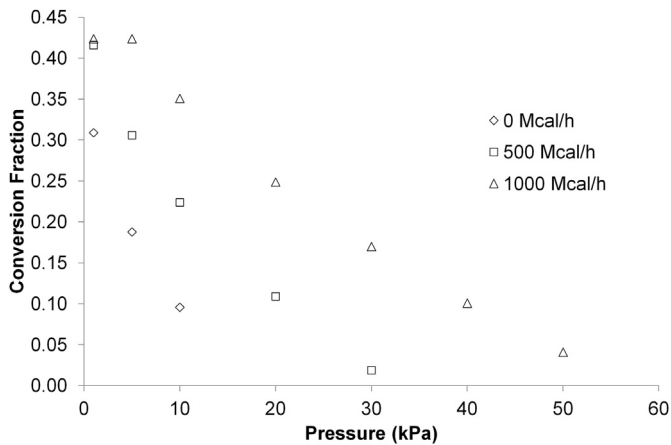

Fig. 13. Effect of the pressure on the conversion fraction in the crystallizer at different amounts of heat added.

an important parameter to control this stage, due to the fact it determines the LiOH concentration in the solution obtained at the first thickener, 6–10%. In Table 3 are shown the operation conditions and the LiOH concentration in the resultant streams of each thickener.

### 3.3. Evaporation and crystallization

In this stage the solution is concentrated in LiOH gradually, this is due to it is evaporated by the vacuum applied in each evaporator and the crystallizer, and the heat feed to the first one. In Table 4 are shown the operation conditions in the equipments.

The steam generated in the first evaporator is used in the next equipment which works at lower vacuum pressure, to evaporate and concentrate the solution. In the third effect which is the crystallizer, the solution is saturated in LiOH and later supersaturated therefore  $\text{LiOH} \cdot \text{H}_2\text{O}$  crystallizes. To control the supersaturation and crystallization, the pressure and temperature are determinant. The resultant suspension is at 70 °C. The main impurity in the solution is potassium sulfate, about 5%, but this does not crystallize. The 60% of the solution is recycled to the crystallizer.

### 3.4. Drying, classification and packing

The cake obtained after filtrating the suspension above, has a humidity of 4%, decreasing it after drying to 0.4%. The solid is classified in an intermediate size range, between 20 and 50 US mesh being that granulometry for the final product. The stream 41 contains it, the process yield is greater than 98% and with a purity 99%.

## 4. Discussion

### 4.1. Effect of fresh water for washing feed on the thickener system

In the dissolution and conversion stage, the main parameter is the LiOH concentration in the resultant solution. This concentration depends on the ratio of lithium carbonate to calcium hydroxide feed. It was determined that the feed should be stoichiometric to convert all the lithium carbonate to lithium hydroxide and minimize the consumption of calcium hydroxide.

Three different scenarios were simulated for LiOH concentration in the solution, 8, 10 and 12%. For each scenario was studied the

effect of fresh water feed for washing on the concentration of LiOH at the outlet stream of the thickeners system.

It was found that the fresh water feed to the thickener 4 (see Fig. 4) dilutes the solution. This effect is shown in Fig. 8. It can be observed that increases of fresh water decreases the LiOH concentration ( $C_{\text{sLiOH}}$ ) in the overflow of this step.

To improve the process yield, the lithium loss in the calcium carbonate discarded must be reduced (underflow thickener 4). In Fig. 9 is shown the relationship between the fresh water used for washing with and the lithium loss for different concentrations of LiOH in the solution feed. It can be seen that at lower flow rate of fresh water the lithium loss are high and this loss increases at high concentrations of LiOH. There is a minimum flow rate of water to reduce the lithium loss significantly.

Based on the results shown in Figs. 8 and 9 was determined that the optimum flow rate of fresh water for washing is 2000 kg/h, this for reducing the amount of lithium loss in the discard.

### 4.2. Effect of LiOH concentration in solution fed to evaporators

The effect of the LiOH concentration in the feed to evaporators on the heat required in this stage was analyzed. For that reason different concentrations of lithium hydroxide were studied, stream 20. The main results are shown in Fig. 10.

It was determined that as higher the concentrations of LiOH in the feed solution ( $C_{\text{sLiOH}}$ ), the required heat decreases due to the fact that is necessary to evaporate less amount of water to reach the desire concentrations.

To determine the optimal energy consumption in the evaporators, different scenarios were studied. The scenarios were considered at a concentration of 12% in LiOH for the solution feed to the thickener system.

*Scenario 1.* Thickening without washing. For this case was found there is no dilution of the solution and the maximum lithium loss is 5 kg/h. It is not necessary to add extra heat to the system. The solution is concentrated by the recycle saturated solution.

*Scenario 2.* For a fresh water feed of 1000 kg/h, a solution of 9.9% in LiOH for feeding the evaporator was obtained and the lithium loss is 0.9 kg/h. The required heat is 700,000 kcal/h as shown in Fig. 10.

*Scenario 3.* For a fresh water feed of 2000 kg/h, a solution of 8.4% in LiOH for feeding the evaporator was obtained and the lithium loss is 0.25 kg/h. The required heat is 1,400,000 kcal/h as shown in Fig. 10. The main advantage for this case is that the lithium loss is 0.25 kg/h.

The simulation results for the three scenarios are shown in Table 5.

As can be seen in Table 5, the scenario 1 is the most favorable considering the consumption of energy, but presents a high lithium loss. The scenario 3 reduces the lithium loss significantly but requires the highest consumption of energy, therefore to choose the optimal operation conditions the effect of this stage in the process and economical considerations should be taking account.

### 4.3. Effect of the pressure and temperature on the crystallizer

The effect of the pressure and temperature inside the crystallizer were studied. It was found that the pressure determines the average temperature in the crystallizer as shown in Fig. 11.

The temperature depends on the pressure, and they are proportional, as the pressure decreases the temperature decreases. It can be observed that the amount of heat at constant pressure and temperature do not affect the liquid–vapor equilibrium, however, that heat promotes the water evaporation, because of the heat wider the latent heat zone, increasing the solution concentration in

**Table 6**  
Indices for the conventional and modified processes.

| Process   | LiOH concentration in the solution fed to settlers (%) |          |              |          |              |          |
|---|--|----------|--------------|----------|--------------|----------|
|   | 8  |          | 10           |          | 12           |          |
|   | Conventional   | Modified | Conventional | Modified | Conventional | Modified |
| Li <sub>2</sub> CO <sub>3</sub> (kg/h)              | 704  | 704      | 704          | 704      | 704          | 704      |
| Purity of the product (%)                           | 97.55  | 99.46    | 97.89        | 99.49    | 97.92        | 99.51    |
| Process yield (%)                                   | 96.59  | 98.91    | 96.45        | 98.82    | 96.32        | 98.68    |
| Mass of the product (kg/h)                          | 614.4  | 788.3    | 611.4        | 787.3    | 610.4        | 786.1    |
| Required heat for evaporation (kcal/kg product)     | 2613   | 2711     | 1476         | 1595     | 658          | 944      |
| Purge steam (kg/kg product)                         | 9.15   | 8.85     | 7.33         | 7.06     | 6.02         | 6.04     |
| Water required (kg/kg product)                      | 10.09  | 9.45     | 8.29         | 7.92     | 6.98         | 6.92     |
| Li loss in CaCO <sub>3</sub> (kg/kg product)        | 0.001  | 0.001    | 0.001        | 0.001    | 0.002        | 0.001    |
| Li loss in the solution discarded (kg/kg product)   | 0.006  | 0.001    | 0.006        | 0.001    | 0.006        | 0.001    |
| Required heat in the crystallizer (kcal/kg product) | 2542   | 2307     | 2574         | 2333     | 2595         | 2359     |
| Other heat requirements (kcal/kg de product)        | 428  | 334      | 430          | 334      | 431          | 335      |
| Total heat requirements (kcal/kg de product)        | 5583   | 5351     | 4480         | 4262     | 3684         | 3637     |

**Table 7**  
Water mass balance for the modified process at 12% LiOH concentration in the solution fed to the thickeners system.

| kg/h         | In      | Out     | Steam in | Steam out | Consumed | Generated | Balance |
|--------------|---------|---------|----------|-----------|----------|-----------|---------|
| Mixer 1      | 1803.53 | 1633.33 |          |           | 170.2    |           | 0       |
| Mixer 2      | 1628.43 | 1628.08 |          |           | 0.35     |           | 0       |
| Reactor 1    | 4359.75 | 4359.75 |          |           |          |           | 0       |
| Thickeners   | 5315.56 | 5315.55 |          |           |          |           | 0       |
| Evaporator 1 | 5902.25 | 5125.75 | 194.12   | 970.61    |          |           | 0       |
| Evaporator 2 | 5125.75 | 4942.96 | 239.82   | 422.61    |          |           | 0       |
| Crystallizer | 7299.25 | 3132.77 | 959.28   | 4701.94   | 423.82   |           | 0       |
| Dryer        | 31.06   | 1.3     |          | 26.13     | 3.63     |           | 0       |
| Mixer 3      | 1006.43 | 1098.34 |          |           |          | 91.91     | 0       |

LiOH. The amount of heat determines at low pressure a minimum operation temperature in the crystallizer. In the case of 1000 Mcal/h, the minimum temperature is 40 °C (See Fig. 11).

In Figs. 12 and 13 are presented the results of the simulation of the conversion at different temperatures, pressures and heat flow.

It can be seen in Fig. 12 that at 70 °C and 1000 Mcal/h, the conversion is four times greater, 24.7%, therefore it is favorable to add heat to the crystallizer.

In Fig. 13 it can be seen that at 5 kPa, the conversion at 0 Mcal/h and 500 Mcal/h are 19% and 32% respectively, being the conversion increasing at the last condition 84%. For 1000 Mcal/h the conversion is 40%, increasing two times respect to the operation without adding heat.

In Figs. 12 and 13, it can be seen that as the pressure decreases the conversion increases, this could be explained by the dependence of the LiOH solubility in water with the temperature, increasing the solubility as temperature increases. The adding of heat promotes the conversion, therefore it was determined that the operational conditions for reaching the maximum conversion, 42%, in the crystallizer are 5 kPa and 40 °C and adding 1000 Mcal/h.

#### 4.4. Models comparison

For the comparison of the conventional and modified processes in Table 6 is presented the main parameters considered for each scenario.

For all the scenarios the same feed and purity of lithium carbonate and lime were used.

It was found that the purity of the product is independent of the LiOH concentration feed to the thickeners system. The purity for the conventional and modified processes was in the ranges of 97.5% and 99.46–99.51% respectively. The yield for the modified process is 2.4% greater than the corresponding to the conventional one. It is due to the recirculation implemented for this process.

For the modified process 28% more mass of product is obtained, the required heat per kg of product in the process decreases between 1 % and 4.8 %, and the lithium loss per kg of product decreases in 83% in comparison to the conventional one.

The LiOH concentration in the solution fed to thickeners affects the amount of heat required in the crystallizer, because of the fact that as the concentration decreases the amount of heat required for reaching the saturation increases. The water consumption per

**Table 8**  
Energy balance for the modified process at 12% LiOH concentration in the solution fed to the thickeners system.

| Process step | Input stream (1000*kcal/h) | Heat react (1000*kcal/h) | Heat reqrd (1000*kcal/h) | Heat loss (1000*kcal/h) | Output stream (1000*kcal/h) |
|--------------|----------------------------|--------------------------|--------------------------|-------------------------|-----------------------------|
| Mixer 1      | -9                         | 147                      |                          | -135                    | -3                          |
| Mixer 2      | -8.4                       | 1                        |                          |                         | 7.4                         |
| Reactor 1    | -8                         | -57                      | 248                      |                         | -183                        |
| Evaporator 1 | 218                        | -454                     | 715                      |                         | -479                        |
| Evaporator 2 | 453                        | -107                     | 0                        |                         | -346                        |
| Crystallizer | 478                        | -2077                    | 1855                     |                         | -256                        |
| Dryer        | 15                         | -14                      | 14                       |                         | -15                         |
| Mixer 3      | -2                         | -24                      | 23                       |                         | 3                           |

**Table 9**

The particle size distribution of the final product.

| Screens | Micron | Flow, kg/h | % Ret  | % Pas |
|---------|--------|------------|--------|-------|
| 20 US   | 841    | 3.93       | 0.502  | 99.5  |
| 35 US   | 500    | 258.11     | 33.015 | 66.48 |
| 50 US   | 297    | 501.98     | 64.211 | 2.27  |
| 80 US   | 177    | 16.66      | 2.131  | 0.14  |
| 120 US  | 125    | 1.11       | 0.141  | 0     |

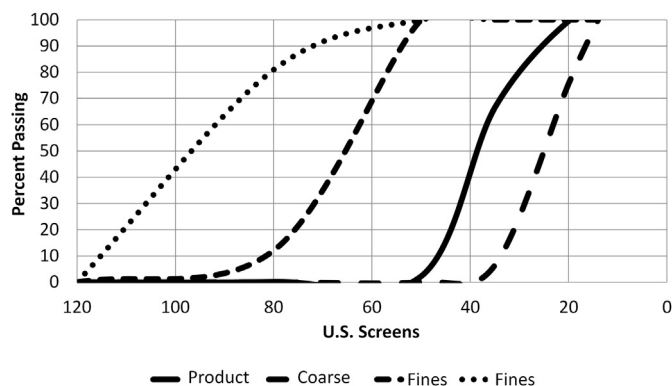
**Fig. 14.** The cumulative particle size distribution of the  $\text{LiOH}\cdot\text{H}_2\text{O}$  classified by size.

kilogram of product for the modified process is 1%. This is 6.3% smaller than the corresponding to the conventional process.

It was determined that the optimal  $\text{LiOH}$  concentration is 12% due to at this concentration the process yield is the highest and the water and energy consumption are the lowest.

The specific consumption of water and energy for the conventional process are 6.98 kg of water/kg product and 3684 kcal/kg product, respectively. For the modified process the water and energy indices are 6.92 kcal/kg product and 3637 kcal/kg product, therefore the modified process uses more efficient the energy but the water consumed is similar for both processes.

For the modified process at 12%  $\text{LiOH}$  concentration in the solution fed to the thickeners system, the water mass and energy balances are presented in Tables 7 and 8, respectively.

In Table 8 is shown that the greater energy consumption is for the crystallizer. This is for reaching a high conversion to  $\text{LiOH}\cdot\text{H}_2\text{O}$ .

#### 4.5. Particle size distribution of the final product

It was found that the particle size distribution of the final product is the same for the conventional and modified processes. The particle size distribution of the final product is shown in Table 9.

In Fig. 14 the cumulative distribution of the crystals classified by size is shown for fines (stream 42 and 45), coarse (stream 40) and product (stream 41). It can be observed that the product size satisfy the standard for  $\text{LiOH}\cdot\text{H}_2\text{O}$ .

## 5. Conclusions

The purity of the product is independent of the concentration used in the feed to the thickening system. The product purity obtained is in the range from 97.5 % to 98% and from 99.46 % to 99.51%,

for the conventional and modified processes respectively. The process yield increases on average 2.4% for the modified process, because of the recycling of solution and suspensions.

In the modified process 28% more product mass is obtained, the specific energy consumption decreases from 1% to 4.8% and losses of lithium per kg of product decreases by 83% than for the conventional process.

The water consumption per kg of product in the modified process is between 1% and 6.3% lower than in the conventional process.

The particle size of the product is in the range of 20–50 U.S. mesh, this is in accordance with the technical specifications for lithium hydroxide monohydrate.

The optimal operational condition for an efficient use of water and energy and better performance of the process is: 1000 kg/h of water for washing, a feed to the thickening system, of suspension with 12% in  $\text{LiOH}$  concentration in its solution, a pressure in the crystallizer in the range from 5 kPa to 25 kPa and adding heat to this equipment of at least 1000 Mcal/h.

## Acknowledgments

The authors acknowledge to FONDECYT (grant N° 1120192), CONICYT/FONDAP N° 15110019 SERC-Chile, and the Education Ministry of Chile Grant PMI ANT 1201 for the financial support.

## References

- [1] Mei Z, Wen W. Seasonal energy utilization optimization in an enterprise. *Energy* 2010;35(9):3932–40.
- [2] Pirouti M, Bagdanavicius A, Ekanayake J, Wu J, Jenkins N. Energy consumption and economic analyses of a district heating network. *Energy* 2013;57:149–59.
- [3] Wei X, Xu G, Kusiak A. Modeling and optimization of a chiller plant. *Energy* 2014;73:898–907.
- [4] Descoins N, Deleris S, Lestienne R, Trouvé E, Maréchal F. Energy efficiency in waste water treatments plants: optimization of activated sludge process coupled with anaerobic digestion. *Energy* 2012;41(1):153–64.
- [5] Giacone E, Manco S. Energy efficiency measurement in industrial processes. *Energy* 2012;38(1):331–45.
- [6] Lin WS, Lee M, Huang YC, Den W. Identifying water recycling strategy using multivariate statistical analysis for high-tech industries in Taiwan. *Resour Conserv Recycl* 2015;94:35–42.
- [7] Klemeš J. Industrial water recycle/reuse. *Curr Opin Chem Eng* 2012;1(3): 238–45. <http://dx.doi.org/10.1016/j.coche.2012.03.010>.
- [8] Gouws J, Majazi T, Foo D, Chen C, Lee J. Water minimization techniques for batch processes. *Ind Eng Chem Res* 2010;49:8877–93.
- [9] Garrett DE. Part 1-Lithium. In: Garrett DE, editor. *Handbook of lithium and natural calcium chloride*. Oxford: Academic Press; 2004. p. 1–235.
- [10] Wilkomirsky I. Extractive metallurgy of the lithium. *Minerals* 1998;52(221). ISSN: 0026-458X:31–6 [In Spanish].
- [11] Hader RN, Nielsen RL, Herre MG. Lithium and its compounds. *Ind Eng Chem* 1951. <http://dx.doi.org/10.1021/ie50504a013>.
- [12] Ryabtsev AD, Nemkov NM, Kotsupalo NP, Serikova LA. Preparation of high-purity lithium hydroxide monohydrate from technical-grade lithium carbonate by membrane electrolysis. *Russ J Appl Chem* 2004;77(7):1108–16.
- [13] Nemkov NM, Ryabtsev AD, Mukhin VV. Obtaining high-clean monohydrate of lithium hydroxide from lithium-containing wastes from different plants. *Bull Tomsk Polytech Univ* 2004;307(7):80–4 [In Russian].
- [14] Qing Lv, Zheng S, Du H, Wang S, Zhang Y. Application of METSIM in process design of the cleaner chromate production using sub-molten salt. *Int J Biosci Biotechnol* April, 2013;5(2).
- [15] Qiuyue Z, Northeastern U, Tingan Z, Guozhi L, Xiaofeng Z. Application of process simulation software METSIM in metallurgy. *TELKOMNIKA Indones J Electr Eng* 2012;10:2202–8. <http://dx.doi.org/10.11591/telkomnika.v10i8.1660>.
- [16] Werther J, Gruhn G, Reimers C. Flowsheet simulation of solids processes data reconciliation and adjustment of model parameters. *Chem Eng Process* 2008;47:138–58.
- [17] METSIM Process Simulator ([www.metsim.com](http://www.metsim.com)). Last access: 12.17.14.
- [18] Seidell A. Solubilities of inorganic and organic substances: a handbook of the most reliable quantitative solubility determinations. D. Van Nostrand Company; 1907.